

# Seria **POP** / **POP** series / **POP**-serie

Produkty serii POP wykonane z trwałego tworzywa ABS ze względu na swoją atrakcyjną cenę i wzornictwo są powszechnie stosowane w szkołach, restauracjach, biurach, itp.

POP series products, which are made of durable ABS plastic, have become commonly used in schools, restaurants, offices, and other places owing to their attractive price and design.

Die aus beständigem ABS-Kunststoff gefertigten Produkte aus der POP-Serie kommen aufgrund deren attraktiven Preises und Designs in Schulen, Restaurants oder Büros sehr häufig zum Einsatz.

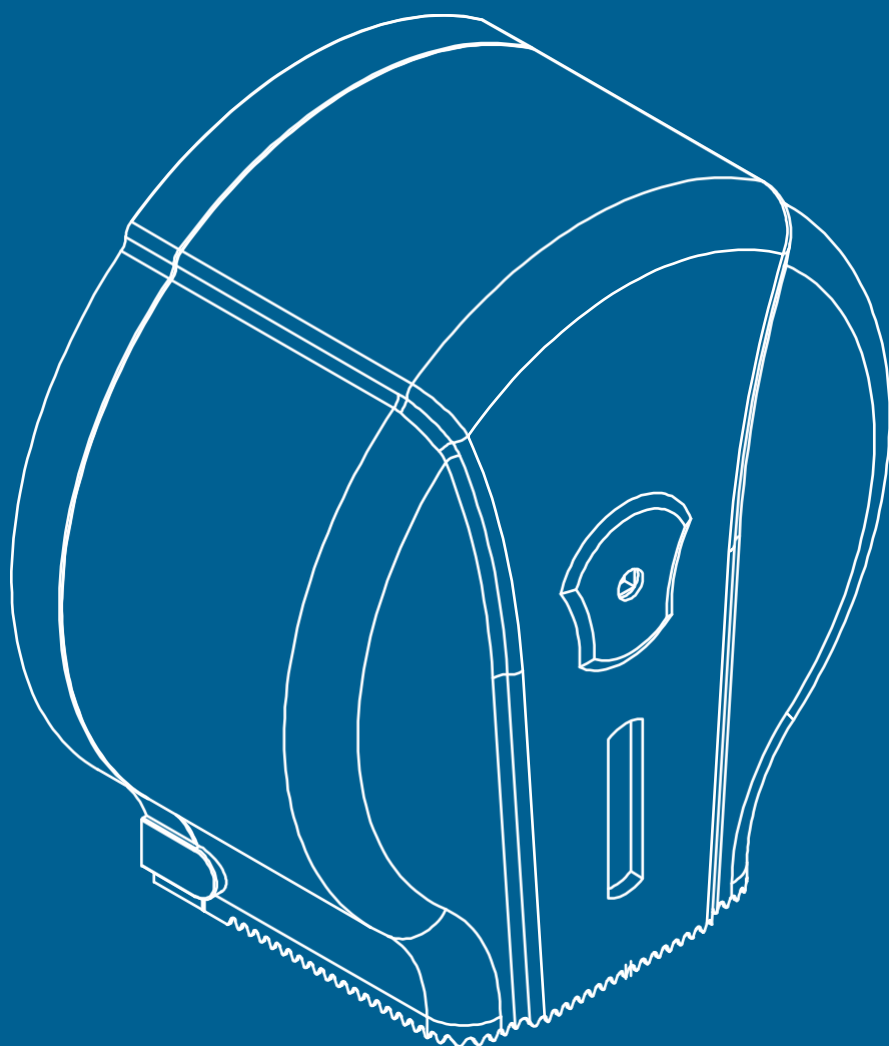

## S500PGWG

### Dozownik mydła w płynie 0,5l POP / Liquid soap dispenser 0,5l POP / Flüssigseifenspender 0,5l POP

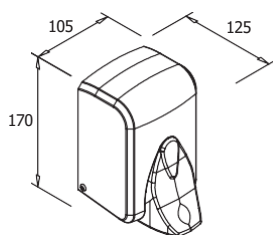

Materiał / material / werkstoff:	plastik ABS / plastic ABS / ABS-Kunststoff
Kolor / colour / farbe:	biały / white / weiß
Pojemność / capacity / fassungsvermögen:	0,5l (500ml)
Napełnianie / filling / auffüllung:	z kanistra / of the canister / aus dem Kanister
Wymiary / dimensions / maße des Seifenspenders:	170 x 105 x 125 mm
Rodzaj montażu / mounting / befestigung:	naścienny / wall-mounted / an der Wand



## SA500PGWG

### Dozownik łokciowy mydła w płynie 0,5l POP / Elbow dispenser 0,5l POP / Armhebelspender 0,5l POP

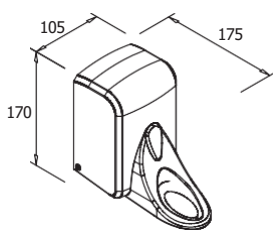

Materiał / material / werkstoff:	plastik ABS / plastic ABS / ABS-Kunststoff
Kolor / colour / farbe:	biały / white / weiß
Pojemność / capacity / fassungsvermögen:	0,5l (500ml)
Napełnianie / filling / auffüllung:	z kanistra / of the canister / aus dem Kanister
Wymiary / dimensions / maße des Seifenspenders:	170 x 105 x 175 mm
Rodzaj montażu / mounting / befestigung:	naścienny / wall-mounted / an der Wand



## SF500PGWG

### Dozownik mydła w pianie 0,5l POP / Foam soap dispenser 0,5l POP / Schaumseifenspender 0,5l POP

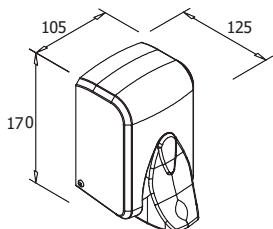

Materiał / material / werkstoff:	plastik ABS / plastic ABS / ABS-Kunststoff
Kolor / colour / farbe:	biały / white / weiß
Pojemność / capacity / fassungsvermögen:	0,5l (500ml)
Napełnianie / filling / auffüllung:	z kanistra / of the canister / aus dem Kanister
Wymiary / dimensions / maße des Seifenspenders:	170 x 105 x 125 mm
Rodzaj montażu / mounting / befestigung:	naścienny / wall-mounted / an der Wand



## S1000PGWG

### Dozownik mydła w płynie 1l POP / Liquid soap dispense 1l POP / Flüssigseifenspender 1l POP

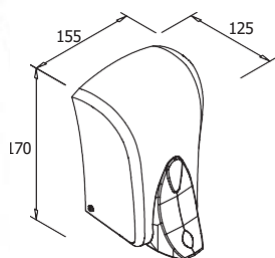

Materiał / material / werkstoff:	plastik ABS / plastic ABS / ABS-Kunststoff
Kolor / colour / farbe:	biały / white / weiß
Pojemność / capacity / fassungsvermögen:	1l (1000ml)
Napełnianie / filling / auffüllung:	z kanistra / of the canister / aus dem Kanister
Wymiary / dimensions / maße des Seifenspenders:	225 x 155 x 135 mm
Rodzaj montażu / mounting / befestigung:	naścienny / wall-mounted / an der Wand



## SA100PGWG

### Dozownik łokciowy mydła w płynie 1l POP / Elbow dispenser 1l POP / Armhebelspender 1l POP

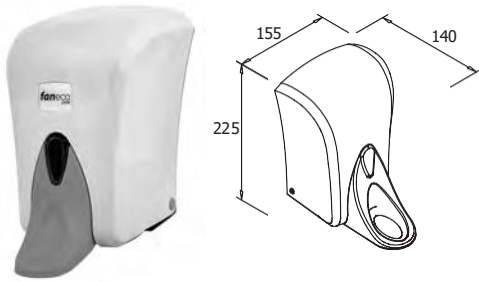

Materiał / material / werkstoff:	plastik ABS / plastic ABS / ABS-Kunststoff
Kolor / colour / farbe:	biały / white / weiß
Pojemność / capacity / fassungsvermögen:	1l (1000ml)
Napelnianie / filling / auffüllung:	z kanistra / of the canister / aus dem Kanister
Wymiary / dimensions / maße des Seifenspenders:	225 x 155 x 170 mm
Rodzaj montażu / mounting / befestigung:	naścienny / wall-mounted / an der Wand

## SA1100PDW

### Automatyczny dozownik mydła w płynie i płynów dezynfekcyjnych 1,1l POP Automatic liquid soap and disinfectant dispenser 1,1l POP Automatischer Spender für Flüssigseife und Desinfektionsmittel 1,1l POP

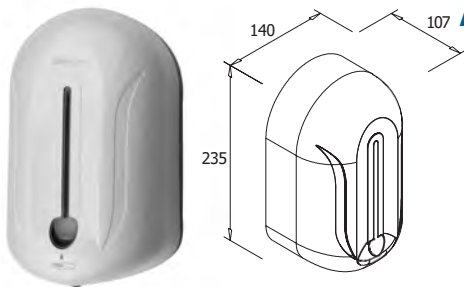

Materiał / material / werkstoff:	plastik ABS / plastic ABS / ABS-Kunststoff
Kolor / colour / farbe:	biały / white / weiß
Pojemność / capacity / fassungsvermögen:	1,1l (1100ml)
Napelnianie / filling / auffüllung:	z kanistra / of the canister / aus dem Kanister
Wymiary / dimensions / maße des Seifenspenders:	235 x 140 x 107 mm
Rodzaj montażu / mounting / befestigung:	naścienny / wall-mounted / an der Wand

## P400PGWG

### Podajnik ręczników ZZ POP / Paper towel dispenser ZZ POP / Papiertuchspender ZZ POP

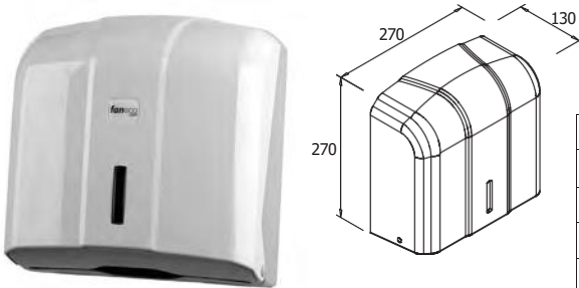

Materiał / material / werkstoff:	plastik ABS / plastic ABS / ABS-Kunststoff
Kolor / colour / farbe:	biały / white / weiß
Pojemność / capacity / fassungsvermögen:	400 listków
Wymiary / dimensions / maße des Seifenspenders:	235 x 140 x 107 mm
Rodzaj montażu / mounting / befestigung:	naścienny / wall-mounted / an der Wand

## PM20PGWG

### Manualny podajnik ręczników w roli POP Manual paper roll towel dispenser POP Rollenpapiertuchspender manuell POP

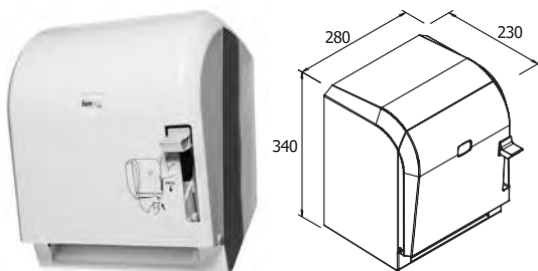

Materiał / material / werkstoff:	plastik ABS / plastic ABS / ABS-Kunststoff
Kolor / colour / farbe:	biały / white / weiß
Pojemność / capacity / fassungsvermögen:	rola max Ø 20 cm, max szerokość 19-20 cm / Roll up to 19 - 20 cm width and Ø 20 cm, pin 35 - 60 mm / Breite max. 19 - 20 cm, max. ø 20 cm, Zapfen 35 - 60 mm
Wymiary / dimensions / maße des Seifenspenders:	340 x 280 x 230 mm
Rodzaj montażu / mounting / befestigung:	naścienny / wall-mounted / an der Wand

## P22PGWG

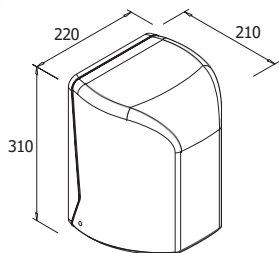

### Podajnik ręczników w roli POP / Paper roll towel dispenser POP / Rollenpapiertuchspender POP

Materiał / material / werkstoff:	plastik ABS / plastic ABS / ABS-Kunststoff
Kolor / colour / farbe:	biały / white / weiß
Pojemność / capacity / fassungsvermögen:	rola o max Ø 20 cm i szerokości 21 cm / roll up to Ø 20 cm and width 21 cm / Rolle mit max. Ø 20 cm und Breite 21 cm
Wymiary / dimensions / maße des Seifenspenders:	310 x 220 x 210 mm
Rodzaj montażu / mounting / befestigung:	naścienny / wall-mounted / an der Wand

## J18PGWG / J29PGWG

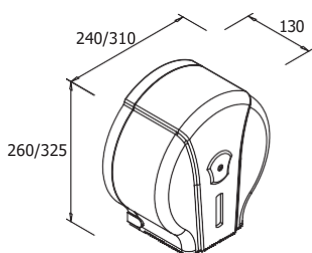

### Pojemnik na papier toaletowy POP S / Toilet paper dispenser POP S / Toilettenpapierbehälter / POP S

Materiał / material / werkstoff:	plastik ABS / plastic ABS / ABS-Kunststoff
Kolor / colour / farbe:	biały / white / weiß
Pojemność / capacity / fassungsvermögen:	Rola Ø 18 - 23 cm, trzpień 4,5 / 5,5 cm / Roll Ø 18 - 23 cm, pin 4,5 / 5,5 cm / Rolle Ø 18 - 23 cm, Zapfen 4,5 / 5,5 cm
Wymiary / dimensions / maße des Seifenspenders:	260 x 240 x 130 mm
Rodzaj montażu / mounting / befestigung:	naścienny / wall-mounted / an der Wand

#### POP M

Pojemność / capacity / fassungsvermögen:	Rola Ø 29 cm, trzpień 5,5 cm / Roll Ø 29 cm, pin 5,5 cm / Rolle Ø 29 cm, Zapfen 5,5 cm
Wymiary / dimensions / maße des Seifenspenders:	325 x 310 x 130 mm

## TP400PGWG

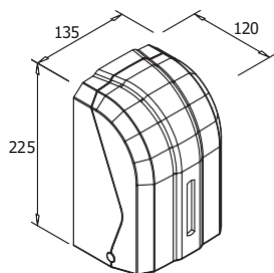

### Pojemnik na papier toaletowy w listkach POP / Toilet paper container POP / Behälter für Toilettenpapier in Blättern POP

Materiał / material / werkstoff:	plastik ABS / plastic ABS / ABS-Kunststoff
Kolor / colour / farbe:	biały / white / weiß
Pojemność / capacity / fassungsvermögen:	400 listków / 400 towels / 400 Papierblätter
Wymiary / dimensions / maße des Seifenspenders:	225 x 135 x 120 mm
Rodzaj montażu / mounting / befestigung:	naścienny / wall-mounted / an der Wand

# Seria **ZEN** / **ZEN** series / **ZEN**-serie

---

Europejskiej produkcji seria ZEN wykonana z białego tworzywa ABS, cechuje się optymalną proporcją jakości do ceny.

The ZEN series manufactured in Europe made of white plastic ABS is characterised by the optimum value for money.

Die ZEN-Serie aus europäischer Produktion aus weißem ABS-Kunststoff zeichnet sich durch ein optimales Preis-Leistungs-Verhältnis.

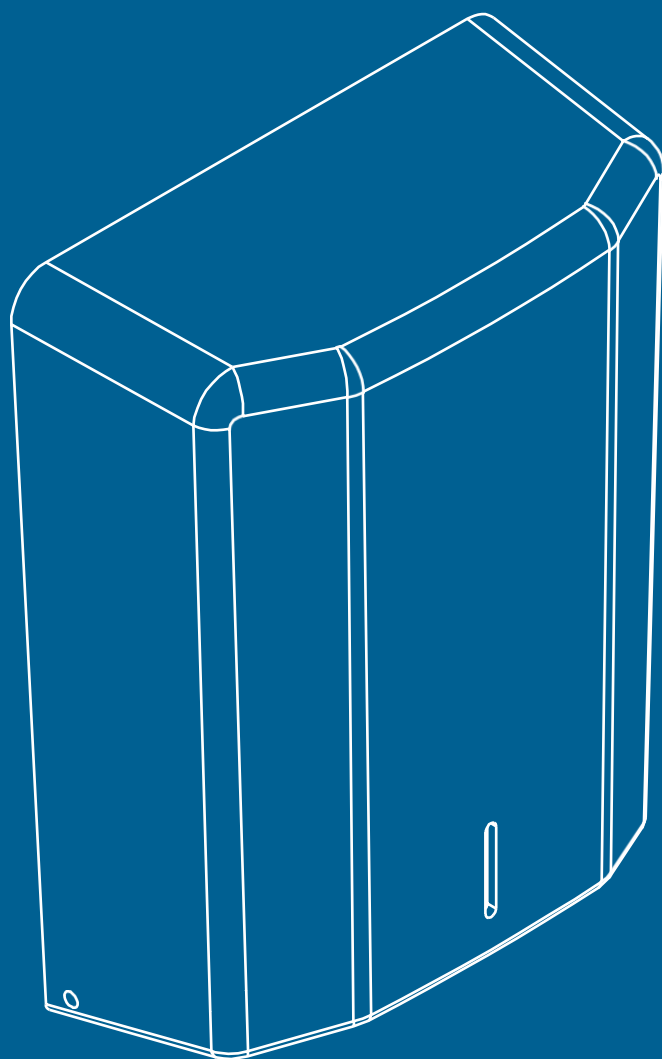

## LCJ1003

### Dozownik mydła w płynie 1l ZEN / Liquid soap dispenser 1l ZEN / Flüssigseifenspender 1l ZEN

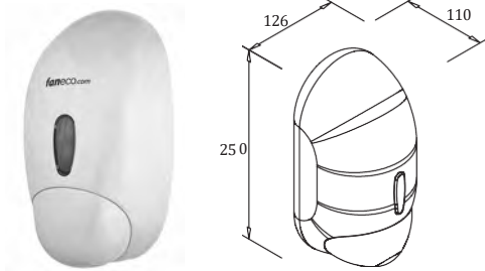

Materiał / material / werkstoff	plastik ABS / plastic ABS / ABS-Kunststoff
Kolor / colour / farbe	biały / white / weiß
Pojemność / capacity / fassungsvermögen	1l (1000ml)
Napełnianie / filling / auffüllung	z kanistra / of the canister / aus dem Kanister
Wymiary / dimensions / maße des Seifenspenders	250 x 126 x 110 mm



## LCJ1005

### Automatyczny dozownik mydła 1l ZEN / Automatic liquid soap dispenser 1l ZEN / Automatischer Flüssigseifenspender 1l ZEN

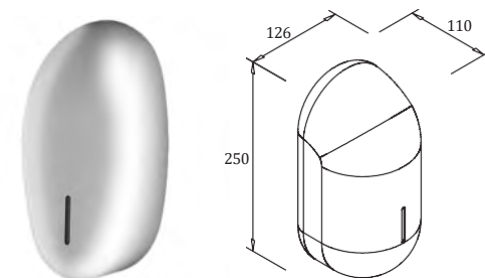

Materiał / material / werkstoff	plastik ABS / plastic ABS / ABS-Kunststoff
Kolor / colour / farbe	biały / white / weiß
Pojemność / capacity / fassungsvermögen	1l (1000ml)
Napełnianie / filling / auffüllung	z kanistra / of the canister / aus dem Kanister
Wymiary / dimensions / maße des Seifenspenders	250 x 126 x 110 mm



## LCP0106B

### Podajnik ręczników ZZ ZEN / Paper towel dispenser ZEN / Papiertuchspender ZZ ZEN

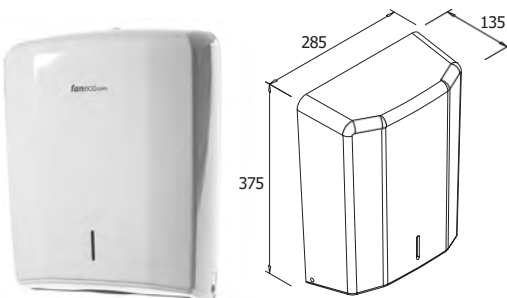

Materiał / material / werkstoff	plastik ABS / plastic ABS / ABS-Kunststoff
Kolor / colour / farbe	biały / white / weiß
Pojemność / capacity / fassungsvermögen	600 listków / 600 towels / 600 papierblätter
Wymiary / dimensions / maße des Seifenspenders	375 x 285 x 135 mm



## LCP0521B

### Podajnik ręczników w roli MIDI ZEN / Paper roll towel dispenser MIDI ZEN / Rollenpapiertuchspender MIDI ZEN

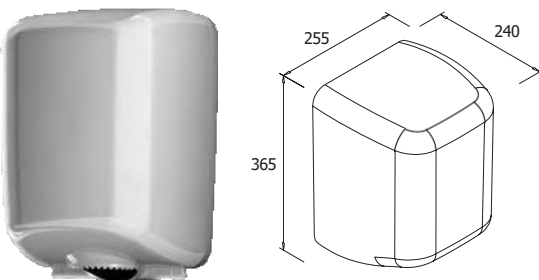

Materiał / material / werkstoff	plastik ABS / plastic ABS / ABS-Kunststoff
Kolor / colour / farbe	biały / white / weiß
Pojemność / capacity / fassungsvermögen	rola midi 24 cm, max $\varnothing$ 22 cm / midi roll 24 cm, up to $\varnothing$ 22 cm / Rolle Midi 24 cm, max. $\varnothing$ 22 cm
Wymiary / dimensions / maße des Seifenspenders	365 x 255 x 240 mm



## LCP0204B

## Pojemnik na papier toaletowy ZEN S / Toilet paper dispenser ZEN S / Toilettenpapierbehälter ZEN S

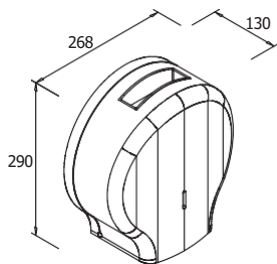

Material / material / werkstoff	plastik ABS / plastic ABS / ABS-Kunststoff
Kolor / colour / farbe	biały / white / weiß
Pojemność / capacity / fassungsvermögen	rola Ø 18 - 23 cm, trzpień 4,5 cm / roll Ø 18 - 23 cm, pin 4,5 cm / Rolle Ø 18 - 23 cm, Zapfen 4,5 cm
Wymiary / dimensions / maße des Seifenspenders	290 x 268 x 130 mm



# Seria **JET** / **JET** series / **JET**-serie

---

Transparentne a przy tym trwale tworzywo ABS to materiał wykorzystywany do produkcji akcesoriów serii JET, dzięki któremu posiadają one neutralny wygląd i łatwość obsługi.

Transparent and durable ABS plastic is used to produce JET series accessories; thanks to the application of ABS, their appearance is neutral, while the use is simple.

Der transparente und dabei äußerst robuste ABS-Kunststoff ist ein Material, welches zur Herstellung von Zubehörteilen aus der JET-Serie verwendet wird, so dass diese durch neutrales Aussehen und einfache Handhabung bestehen.

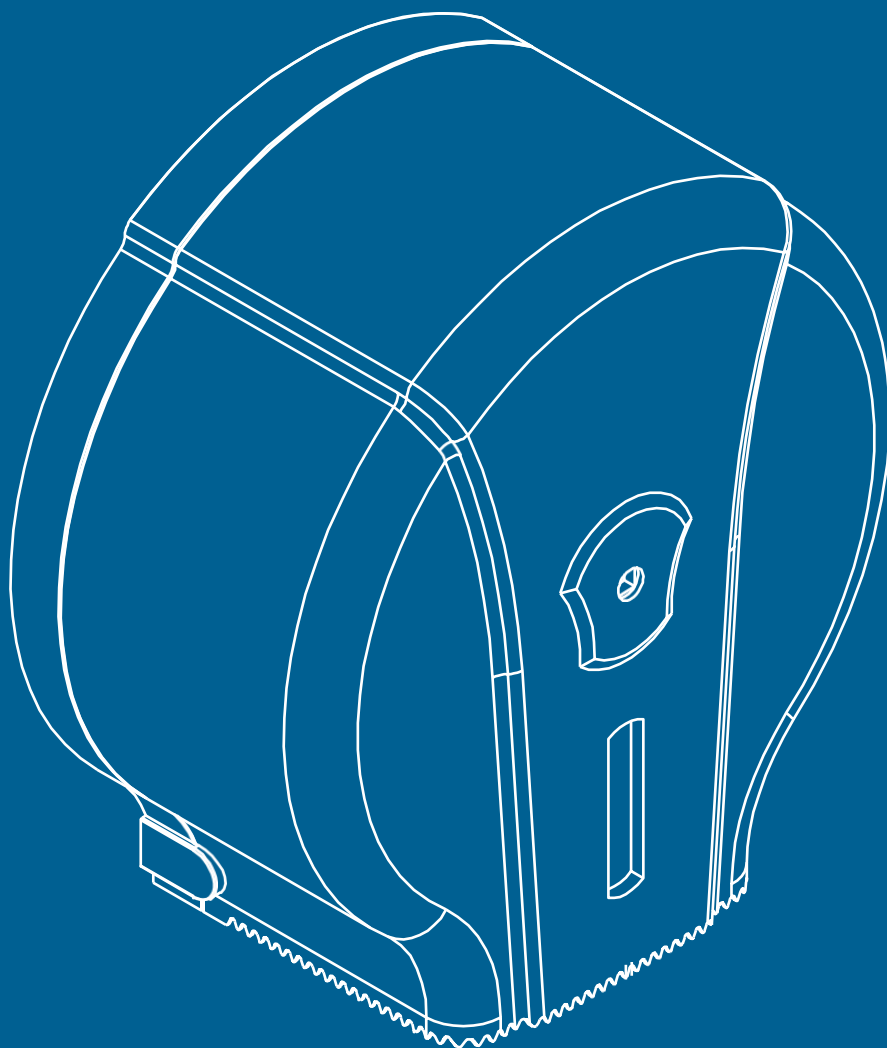



## S500PGWT

### Dozownik mydła w płynie 0,5l JET / Liquid soap dispenser 0,5l JET / Flüssigseifenspender 0,5l JET

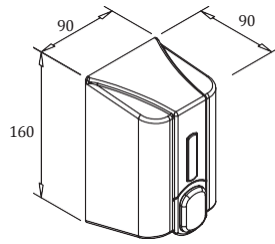

Materiał / material / werkstoff	plastik ABS / plastic ABS / ABS-Kunststoff
Kolor / colour / farbe	transparentny / transparent / transparent
Pojemność / capacity / fassungsvermögen	0,5l (500ml)
Napełnianie / filling / auffüllung	z kanistra / of the canister / aus dem Kanister
Wymiary / dimensions / maße des Seifenspenders	160 x 90 x 90 mm



## S1000PGWT

### Dozownik mydła w płynie 1l JET / Liquid soap dispenser 1l JET / Flüssigseifenspender 1l JET

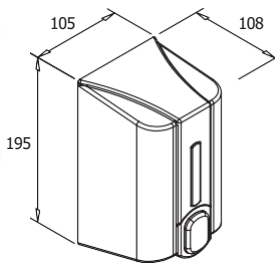

Materiał / material / werkstoff	plastik ABS / plastic ABS / ABS-Kunststoff
Kolor / colour / farbe	transparentny / transparent / transparent
Pojemność / capacity / fassungsvermögen	1l (1000ml)
Napełnianie / filling / auffüllung	z kanistra / of the canister / aus dem Kanister
Wymiary / dimensions / maße des Seifenspenders	195 x 105 x 108 mm



## P400PGWT

### Podajnik ręczników ZZ JET / Paper towel dispenser JET / Papiertuchspender ZZ JET

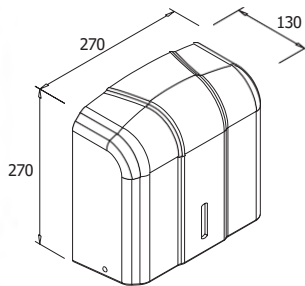

Materiał / material / werkstoff	plastik ABS / plastic ABS / ABS-Kunststoff
Kolor / colour / farbe	transparentny / transparent / transparent
Pojemność / capacity / fassungsvermögen	400 listków / 400 towels / 400 papierblätter
Wymiary / dimensions / maße des Seifenspenders	270 x 270 x 130 mm



## P22PGWT

### Podajnik ręczników w roli JET / Paper roll towel dispenser JET / Rollenpapiertuchspender JET

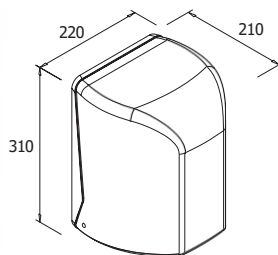

Materiał / material / werkstoff	plastik ABS / plastic ABS / ABS-Kunststoff
Kolor / colour / farbe	transparentny / transparent / transparent
Pojemność / capacity / fassungsvermögen	rola o max Ø 20 cm i szerokości 21 cm / roll up to Ø 20 cm and width 21 cm / Rolle mit max. Ø 20 cm und Breite 21 cm
Wymiary / dimensions / maße des Seifenspenders	310 x 220 x 210mm



## J18PGWT

## Pojemnik na papier toaletowy JET / Toilet paper dispenser JET / Toilettenpapierbehälter JET

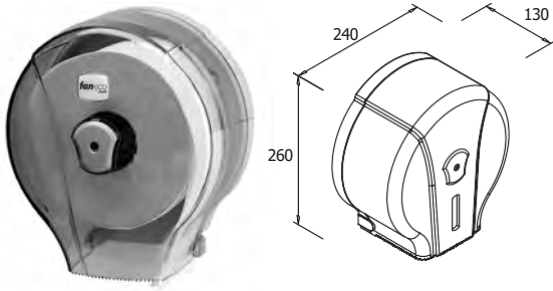

Material / material / werkstoff	plastik ABS / plastic ABS / ABS-Kunststoff
Kolor / colour / farbe	transparentny / transparent / transparent
Pojemność / capacity / fassungsvermögen	rola Ø 18 - 23 cm, trzpień 4,5 / 5,5 cm / roll Ø 18 - 23 cm, pin 4,5 / 5,5 cm / Rolle Ø 18 - 23 cm, Zapfen 4,5 / 5,5 cm
Wymiary / dimensions / maße des Seifenspenders	260 x 240 x 130 mm

# Seria **DUO** / **DUO** series / **DUO**-serie

---

Produkty serii DUO wyróżnia wykonanie ze stali nierdzewnej polerowanej dzięki czemu idealnie komponują się z innymi elementami łazienkowymi wykonanymi chromem.

Products of the DUO series are so special because they are made of polished stainless steel, thus matching other bathroom elements with chromium finish.

Die Produkte aus der DUO-Serie zeichnen sich durch polierten Edelstahl aus, wodurch sie bestens zu anderen verchromten Badezimmerteilen passen.

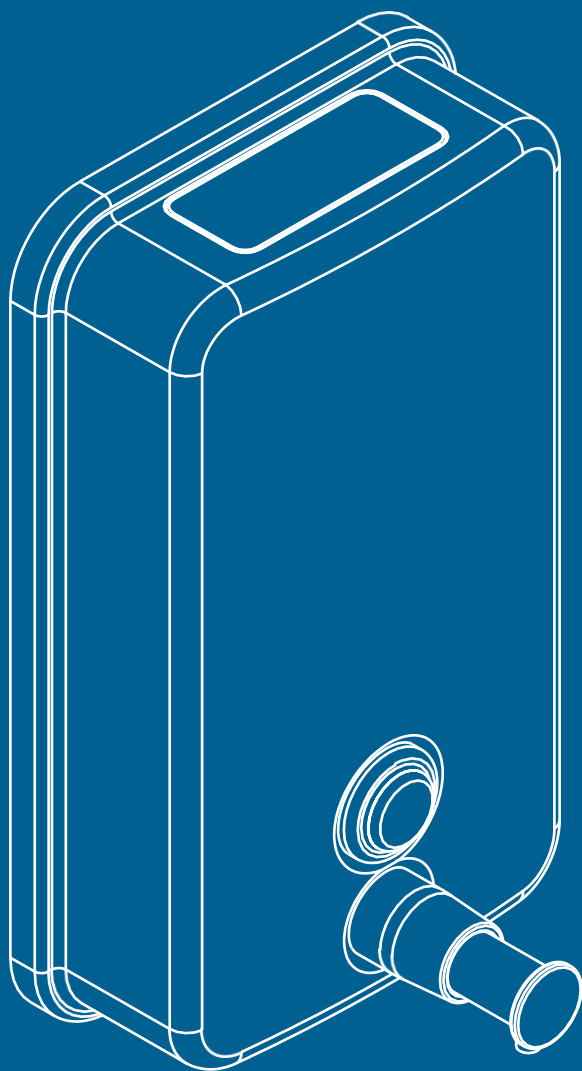

## S500SMP

### Dozownik mydła w płynie 0,5l DUO / Liquid soap dispenser 0,5l DUO / Flüssigseifenspender 0,5l DUO

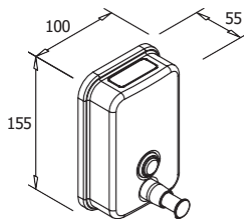

Materiał / material / werkstoff	stal nierdzewna 304 / 304 stainless steel / Edelstahl 304
Kolor / colour / farbe	polysk / brilliance / Glänzend
Pojemność / capacity / fassungsvermögen	0,5l (500ml)
Napełnianie / filling / auffüllung	z kanistra / of the canister / aus dem Kanister
Wymiary / dimensions / maße des Seifenspenders	155 x 100 x 55mm



## S1000SMP

### Dozownik mydła w płynie 1l DUO / Liquid soap dispenser 1l DUO / Flüssigseifenspender 1l DUO

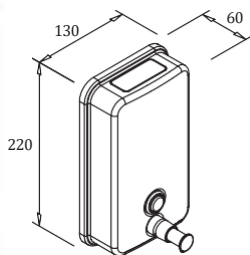

Materiał / material / werkstoff	stal nierdzewna 304 / 304 stainless steel / Edelstahl 304
Kolor / colour / farbe	polysk / brilliance / Glänzend
Pojemność / capacity / fassungsvermögen	1l (1000ml)
Napełnianie / filling / auffüllung	z kanistra / of the canister / aus dem Kanister
Wymiary / dimensions / maße des Seifenspenders	220 x 130 x 60 mm



## N03002.B

### Dozownik mydła w płynie poziomy 1,2l DUO / Horizontal liquid soap dispenser 1,2l DUO / Flüssigseifenspender horizontal 1,2l DUO

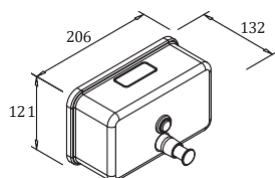

Materiał / material / werkstoff	stal nierdzewna 304 / 304 stainless steel / Edelstahl 304
Kolor / colour / farbe	polysk / brilliance / Glänzend
Pojemność / capacity / fassungsvermögen	1,2l (1200ml)
Napełnianie / filling / auffüllung	z kanistra / of the canister / aus dem Kanister
Wymiary / dimensions / maße des Seifenspenders	121 x 210 x 70 mm



## P300SJP

### Podajnik ręczników ZZ DUO S / Paper towel dispenser DUO S / Papiertuchspender ZZ DUO S

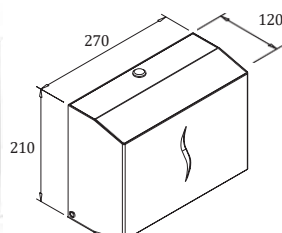

Materiał / material / werkstoff	stal nierdzewna 430 / 430 stainless steel / Edelstahl 430
Kolor / colour / farbe	polysk / brilliance / Glänzend
Pojemność / capacity / fassungsvermögen	300 listków / 300 towels / 300 papierblätter
Wymiary / dimensions / maße des Seifenspenders	210 x 270 x 120 mm



## P600SJP

### Podajnik ręczników ZZ DUO / Paper towel dispenser DUO / Papiertuchspender ZZ DUO

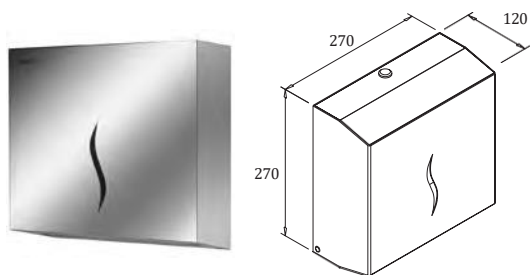

Materiał / material / werkstoff	stal nierdzewna 430 / 430 stainless steel / Edelstahl 430
Kolor / colour / farbe	polysk / brilliance / Glänzend
Pojemność / capacity / fassungsvermögen	600 listków / 600 towels / 600 papierblätter
Wymiary / dimensions / maße des Seifenspenders	270 x 270 x 120 mm



## N04099.B

### Podajnik ręczników w roli MIDI DUO / Paper roll towel dispenser MIDI DUO / Rollenpapiertuchspender MIDI DUO

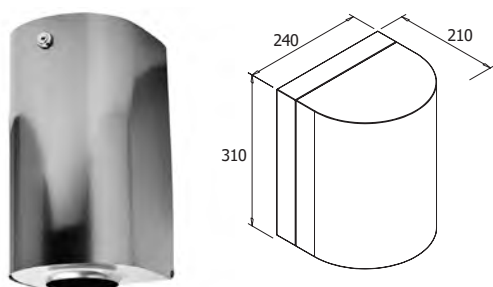

Materiał / material / werkstoff	stal nierdzewna 304 / 304 stainless steel / Edelstahl 304
Kolor / colour / farbe	polysk / brilliance / Glänzend
Pojemność / capacity / fassungsvermögen	rola max Ø 20 cm, max szerokość 21 cm / roll up to Ø 20 cm and width 21 cm / Rolle max. Ø 20 cm, max. Breite 21 cm
Wymiary / dimensions / maße des Seifenspenders	310 x 240 x 210 mm



## N04099.MINI.B

### Podajnik ręczników w roli MINI DUO / Paper roll towel dispenser MINI DUO / Rollenpapiertuchspender MINI DUO

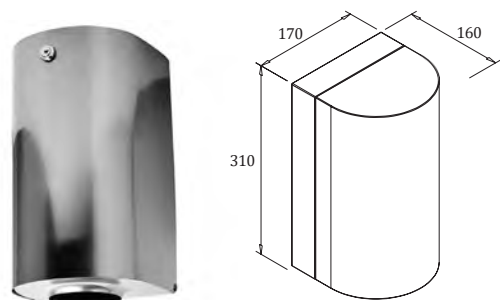

Materiał / material / werkstoff	stal nierdzewna 304 / 304 stainless steel / Edelstahl 304
Kolor / colour / farbe	polysk / brilliance / Glänzend
Pojemność / capacity / fassungsvermögen	rola max Ø 15 cm, max szerokość 21 cm / roll up to Ø 15 cm and width 21 cm / Rolle max. Ø 15 cm, max. Breite 21 cm
Wymiary / dimensions / maße des Seifenspenders	310 x 170 x 160mm



## J25SJP

### Pojemnik na papier toaletowy DUO / Toilet paper dispenser DUO / Toilettenpapierbehälter DUO

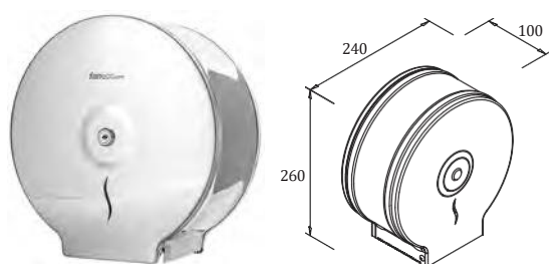

Materiał / material / werkstoff	stal nierdzewna 430 / 430 stainless steel / Edelstahl 430
Kolor / colour / farbe	polysk / brilliance / Glänzend
Pojemność / capacity / fassungsvermögen	rola Ø 18 - 23 cm, trzpień 4,3 cm / roll Ø 18 - 23 cm, pin 4,3 cm / Rolle Ø 18 - 23 cm, Zapfen 4,3 cm
Wymiary / dimensions / maße des Seifenspenders	260 x 240 x 100 mm



# Seria **HIT** / **HIT** series / **HIT**-serie

---

Wykonana ze stali nierdzewnej matowej, jej atrakcyjna cena w połączeniu z uniwersalnym wzornictwem decyduje o jej popularności wśród klientów.

Made of stainless matt steel; its attractive price combined with an universal design make it so popular among customers.

Aus langlebigem Edelstahl gefertigt, deren attraktiver Preis gepaart mit universellem Design ist für die Beliebtheit bei den Kunden ausschlaggebend.

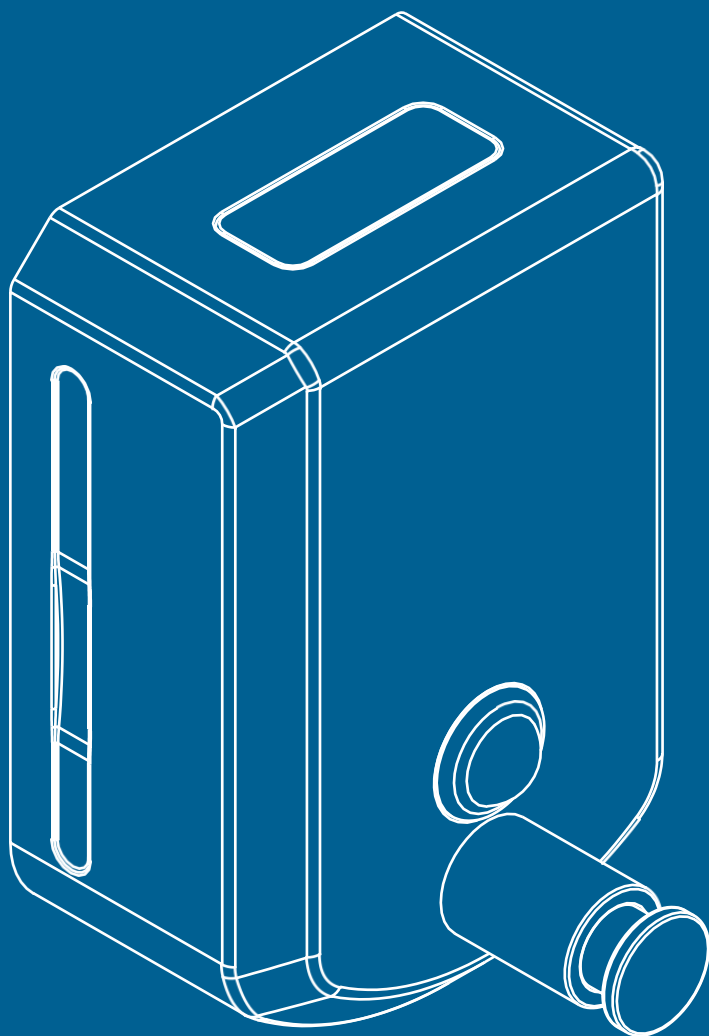

## S500SMB

### Dozownik mydła w płynie 0,5l TOP / Liquid soap dispenser 0,5l TOP / Flüssigseifenspender 0,5l TOP

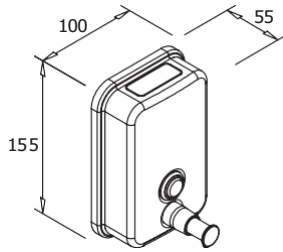

Materiał / material / werkstoff	stal nierdzewna 304 / 304 stainless steel / Edelstahl 304
Kolor / colour / farbe	mat / satin / Matt
Pojemność / capacity / fassungsvermögen	0,5l (500ml)
Napełnianie / filling / auffüllung	z kanistra / of the canister / aus dem Kanister
Wymiary / dimensions / maße des Seifenspenders	155 x 100 x 55mm



## S1000SMB

### Dozownik mydła w płynie 1l TOP / Liquid soap dispenser 1l TOP / Flüssigseifenspender 1l TOP

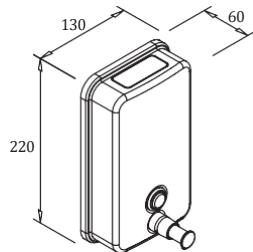

Materiał / material / werkstoff	stal nierdzewna 304 / 304 stainless steel / Edelstahl 304
Kolor / colour / farbe	mat / satin / Matt
Pojemność / capacity / fassungsvermögen	1l (1000ml)
Napełnianie / filling / auffüllung	z kanistra / of the canister / aus dem Kanister
Wymiary / dimensions / maße des Seifenspenders	220 x 130 x 60 mm



## SA500SBB

### Dozownik mydła w płynie 0,5l HIT / Liquid soap dispenser 0,5l HIT / Flüssigseifenspender 0,5l HIT

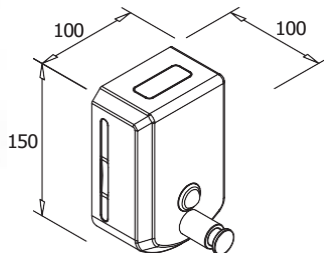

Materiał / material / werkstoff	stal nierdzewna 304 / 304 stainless steel / Edelstahl 304
Kolor / colour / farbe	front-mat, boki-chrom / satin (front), brilliance (sides) / Matt (Vorderseite), poliert (an den Seiten)
Pojemność / capacity / fassungsvermögen	0,5l (500ml)
Napełnianie / filling / auffüllung	z kanistra / of the canister / aus dem Kanister
Wymiary / dimensions / maße des Seifenspenders	150 x 100 x 100 mm



## SA1000SBB

### Dozownik mydła w płynie 1l HIT / Liquid soap dispenser 1l HIT / Flüssigseifenspender 1l HIT

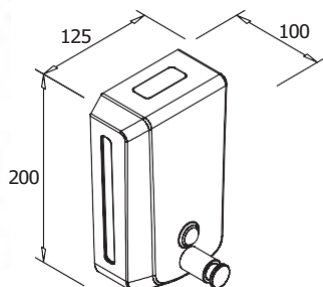

Materiał / material / werkstoff	stal nierdzewna 304 / 304 stainless steel / Edelstahl 304
Kolor / colour / farbe	front-mat, boki-chrom / satin (front), brilliance (sides) / Matt (Vorderseite), poliert (an den Seiten)
Pojemność / capacity / fassungsvermögen	1l (1000ml)
Napełnianie / filling / auffüllung	z kanistra / of the canister / aus dem Kanister
Wymiary / dimensions / maße des Seifenspenders	200 x 125 x 100 mm



## P300SJB

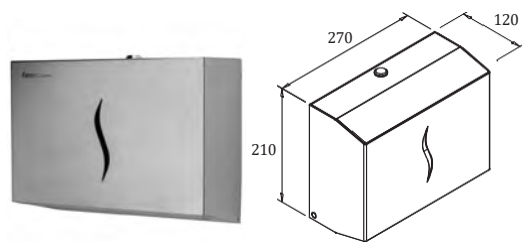

### Podajnik ręczników ZZ HIT S / Paper towel dispenser HIT S / Papiertuchspender ZZ HIT S

Materiał / material / werkstoff	stal nierdzewna 430 / 430 stainless steel / Edelstahl 430
Kolor / colour / farbe	mat / satin / Matt
Pojemność / capacity / fassungsvermögen	300 listków / 300 towels / 300 papierblätter
Wymiary / dimensions / maße des Seifenspenders	210 x 270 x 120 mm

## P600SJB

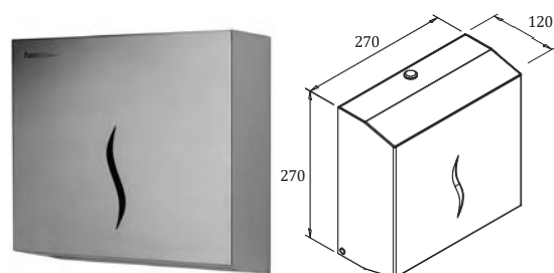

### Podajnik ręczników ZZ HIT / Paper towel dispenser HIT / Papiertuchspender ZZ HIT

Materiał / material / werkstoff	stal nierdzewna 430 / 430 stainless steel / Edelstahl 430
Kolor / colour / farbe	mat / satin / Matt
Pojemność / capacity / fassungsvermögen	600 listków / 600 towels / 600 papierblätter
Wymiary / dimensions / maße des Seifenspenders	270 x 270 x 120 mm

## N04099.S

### Podajnik ręczników w roli MIDI HIT / Paper roll towel dispenser MIDI HIT / Rollenpapiertuchspender MIDI HIT

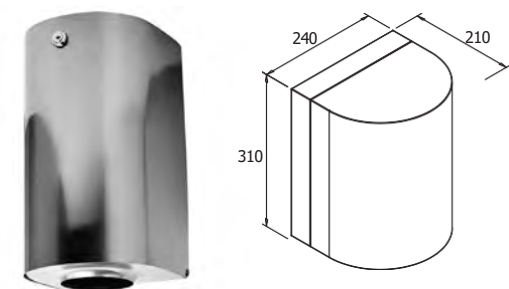

Materiał / material / werkstoff	stal nierdzewna 304 / 304 stainless steel / Edelstahl 304
Kolor / colour / farbe	mat / satin / Matt
Pojemność / capacity / fassungsvermögen	rola max Ø 20 cm, max szerokość 21 cm / roll up to Ø 20 cm and width 21 cm / Rolle max. Ø 20 cm, max. Breite 21 cm
Wymiary / dimensions / maße des Seifenspenders	310 x 240 x 210 mm

## N04099.MINI.S

### Podajnik ręczników w roli MINI HIT / Paper roll towel dispenser MINI HIT / Rollenpapiertuchspender MINI HIT

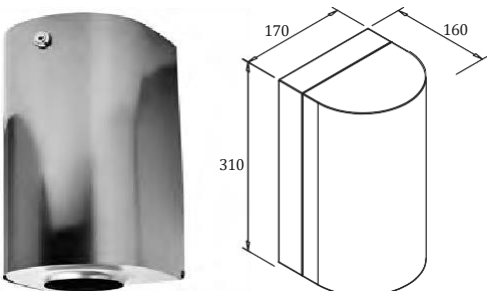

Materiał / material / werkstoff	stal nierdzewna 304 / 304 stainless steel / Edelstahl 304
Kolor / colour / farbe	mat / satin / Matt
Pojemność / capacity / fassungsvermögen	rola max Ø 15 cm, max szerokość 21 cm / roll up to Ø 15 cm and width 21 cm / Rolle max. Ø 15 cm, max. Breite 21 cm
Wymiary / dimensions / maße des Seifenspenders	310 x 170 x 160 mm



## J25SJB

## Pojemnik na papier toaletowy HIT / Toilet paper dispenser HIT / Toilettenpapierbehälter HIT

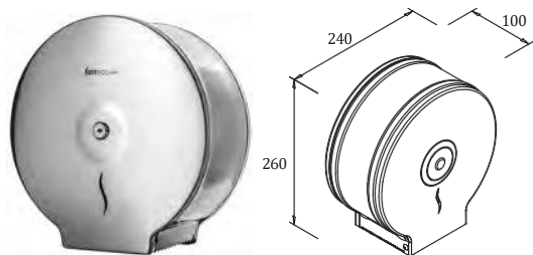

Material / material / werkstoff	stal nierdzewna 430 / 430 stainless steel / Edelstahl 430
Kolor / colour / farbe	mat / satin / Matt
Pojemność / capacity / fassungsvermögen	rola Ø 18 - 23 cm, trzpień 4,3 cm / roll Ø 18 - 23 cm, pin 4,3 cm / Rolle Ø 18 - 23 cm, Zapfen 4,3 cm
Wymiary / dimensions / maße des Seifenspenders	260 x 240 x 100 mm



# Seria **EVO** / **EVO** series / **EVO**-serie

---

Seria EVO wykonana ze stali szlachetnej polerowanej dodaje blasku i prestiżu tworząc poczucie luksusu w toaletach renomowanych restauracji, ośrodków SPA, nowoczesnych gabinetów, klinik i hoteli.

EVO series is made of polished stainless steel, which adds glamour and prestige by creating the sense of luxury in toilets of prestigious restaurants, SPA and wellness centres, modern clinics and hotels.

Die EVO-Serie aus poliertem Edelstahl verleiht Glamour und Prestige mit einem Luxusgefühl in Toiletten renommierter Restaurants, SPA-Zentren, moderner Praxen, Kliniken oder Hotels.

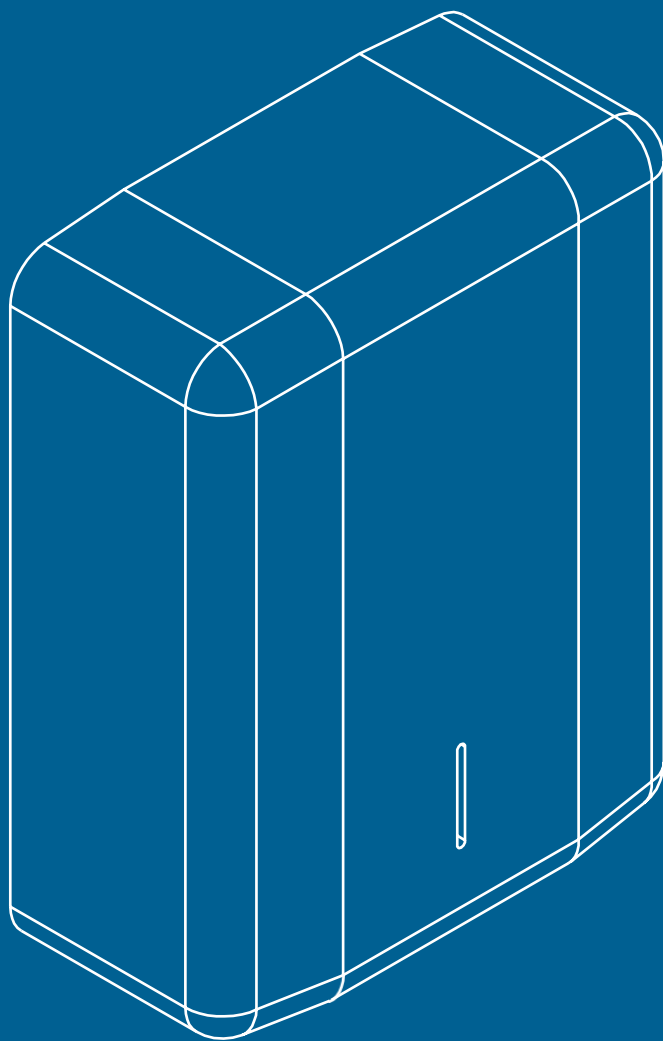

## LCJ1001I

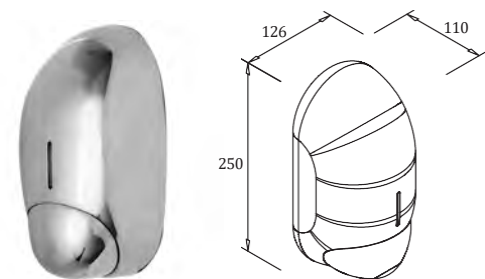

### Dozownik mydła w płynie 1l EVO / Liquid soap dispenser 1l EVO / Flüssigseifenspender 1l EVO

Materiał / material / werkstoff	stal nierdzewna 304 / 304 stainless steel / Edelstahl 304
Kolor / colour / farbe	połysk / brilliance / Glänzend
Pojemność / capacity / fassungsvermögen	1l (1000ml)
Napnianie / filling / auffüllung	z kanistra / of the canister / aus dem Kanister
Wymiary / dimensions / maße des Seifenspenders	250 x 126 x 110 mm

## LCO0107I

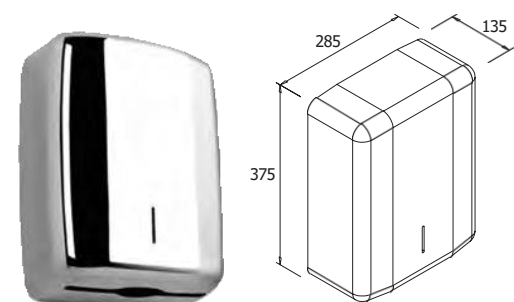

### Podajnik ręczników ZZ EVO / Paper towel dispenser EVO / Papiertuchspender ZZ EVO

Materiał / material / werkstoff	stal nierdzewna 304 / 304 stainless steel / Edelstahl 304
Kolor / colour / farbe	połysk / brilliance / Glänzend
Pojemność / capacity / fassungsvermögen	600 listków / 600 towels / 600 papierblätter
Wymiary / dimensions / maße des Seifenspenders	375 x 285 x 135 mm

## LCO0207I

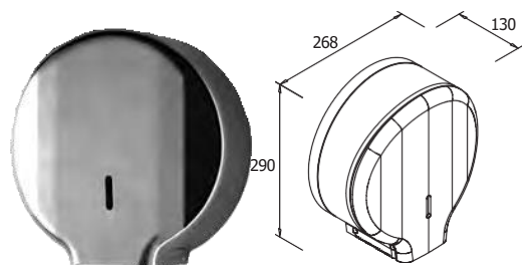

### Pojemnik na papier toaletowy EVO / Toilet paper dispenser EVO / Toilettenpapierbehälter EVO

Materiał / material / werkstoff	stal nierdzewna 304 / 304 stainless steel / Edelstahl 304
Kolor / colour / farbe	połysk / brilliance / Glänzend
Pojemność / capacity / fassungsvermögen	rola Ø 18 - 23 cm, trzpień 4,5 cm / roll Ø 18 - 23 cm, pin 4,5 cm / Rolle Ø 18 - 23 cm, Zapfen 4,5 cm
Wymiary / dimensions / maße des Seifenspenders	290 x 268 x 130 mm

# Seria **GEO** / **GEO** series / **GEO**-serie

---

Prawdziwie elegancka seria akcesoriów GEO ze stali szlachetnej szczotkowanej, europejskiej produkcji spełnia oczekiwania najbardziej wymagających klientów dzięki jej wysokiej jakości, trwałości wykonania oraz niespotykanych kształtów.

A truly elegant series of accessories, GEO, made of brushed stainless steel made in Europe; it meets the expectations of even the most demanding customers, owing to its high quality, durability, and unique shapes.

Die sehr elegante Serie der GEO-Zubehörteile aus gebürstetem Edelstahl aus europäischer Produktion erfüllt selbst die Erwartungen anspruchsvollster Kunden dank der hohen Qualität, Beständigkeit und unnachahmlichen Formen.

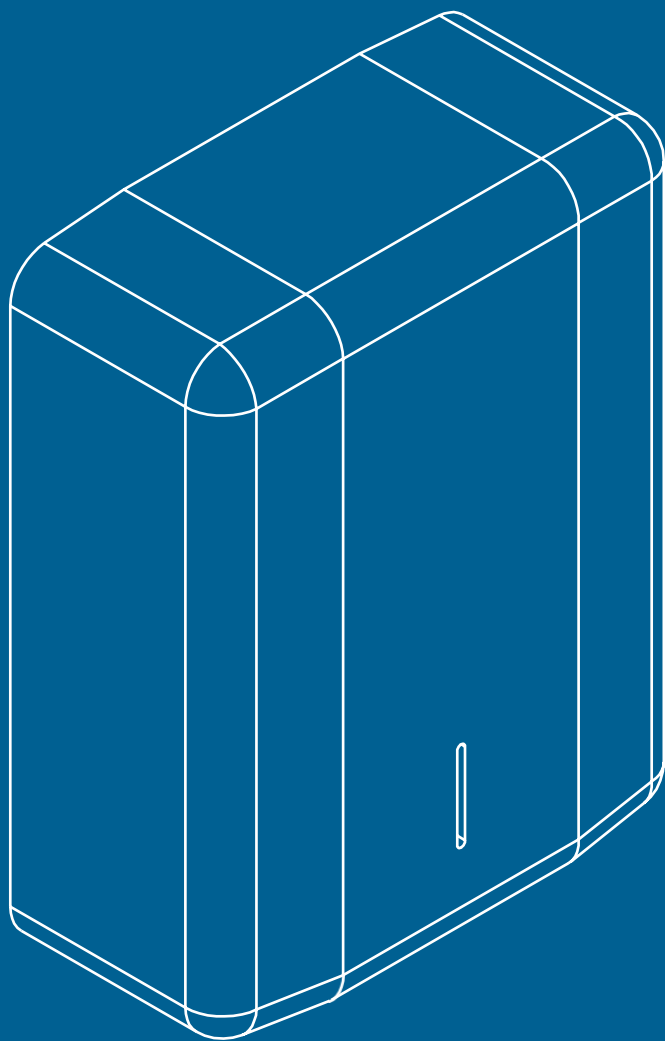

## LCJ1001S

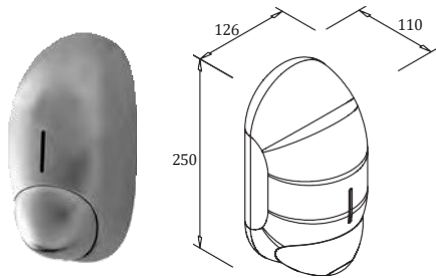

## Dozownik mydła w płynie 1l GEO / Liquid soap dispenser 1l GEO / Flüssigseifenspender 1l GEO

Materiał / material / werkstoff	stal nierdzewna 304 / 304 stainless steel / Edelstahl 304
Kolor / colour / farbe	mat / satin / Matt
Pojemność / capacity / fassungsvermögen	1l (1000ml)
Napełnianie / filling / auffüllung	z kanistra / of the canister / aus dem Kanister
Wymiary / dimensions / maße des Seifenspenders	250 x 126 x 110 mm

## LCO0107S

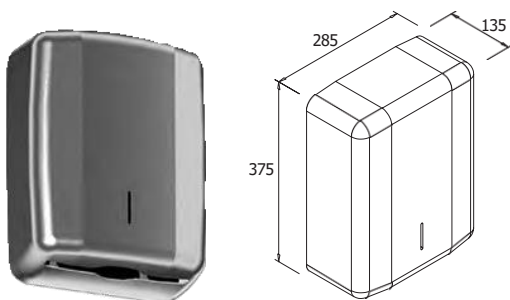

## Podajnik ręczników ZZ GEO / Paper towel dispenser GEO / Papiertuchspender ZZ GEO

Materiał / material / werkstoff	stal nierdzewna 304 / 304 stainless steel / Edelstahl 304
Kolor / colour / farbe	mat / satin / Matt
Pojemność / capacity / fassungsvermögen	600 listków / 600 towels / 600 papierblätter
Wymiary / dimensions / maße des Seifenspenders	375 x 285 x 135 mm

## LCO0207S

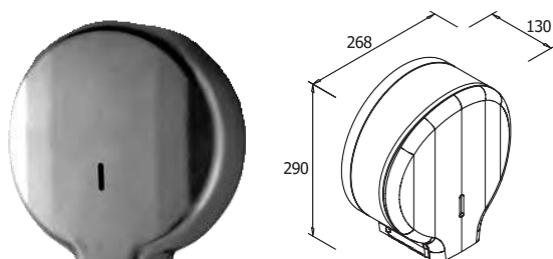

## Pojemnik na papier toaletowy GEO / Toilet paper dispenser GEO / Toilettenpapierbehälter GEO

Materiał / material / werkstoff	stal nierdzewna 304 / 304 stainless steel / Edelstahl 304
Kolor / colour / farbe	mat / satin / Matt
Pojemność / capacity / fassungsvermögen	rola Ø 18 - 23 cm, trzpień 4,5 cm / roll Ø 18 - 23 cm, pin 4,5 cm / Rolle Ø 18 - 23 cm, Zapfen 4,5 cm
Wymiary / dimensions / maße des Seifenspenders	290 x 268 x 130 mm

# Seria **LAB** / **LAB** series / **LAB**-serie

---

Produkty serii LAB wykonane z solidnej stali nierdzewnej szczotkowanej mają szerokie zastosowanie w przemyśle, służbie zdrowia, czy weterynarii – wszędzie tam gdzie liczy się trwałość przy wysokim poziomie eksploatacji oraz znakomita ergonomia użytkownika.

LAB series products made of solid brushed stainless steel find a broad application in industry, healthcare, and veterinary medicine – in all places where durability matters due to intense use. In addition, LAB products are highly ergonomic.

Die Produkte aus der LAB-Serie aus solidem gebürstetem Edelstahl finden breite Anwendung im Gesundheitswesen und in der Veterinärindustrie. Kurzum überall dort wo Beständigkeit bei hoher Betriebsqualität und ausgezeichnete Gebrauchsergonomie oberste Priorität sind.

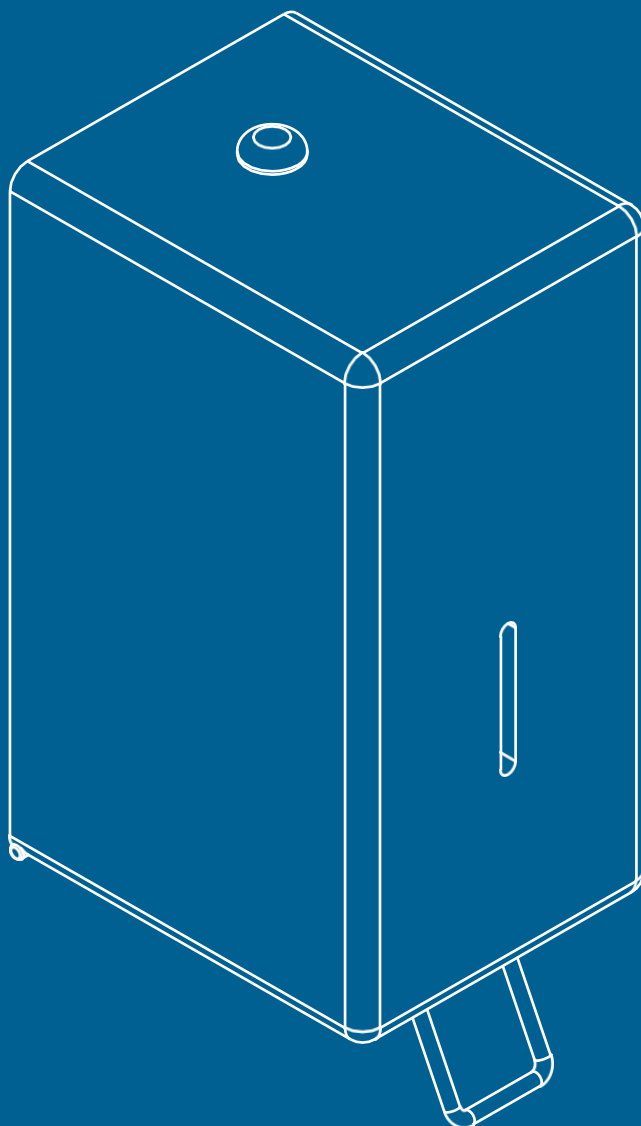

## S820SDB

### Dozownik mydła w płynie 0,8l LAB / Liquid soap dispenser 0,8l LAB / Flüssigseifenspender 0,8l LAB

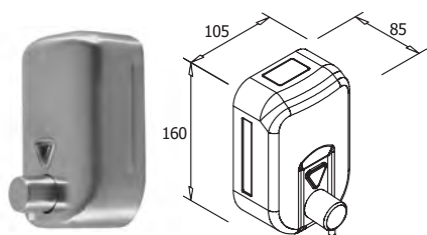

Materiał / material / werkstoff	stal nierdzewna 304 / 304 stainless steel / Edelstahl 304
Kolor / colour / farbe	mat / satin / Matt
Pojemność / capacity / fassungsvermögen	0,8l (800ml)
Napełnianie / filling / auffüllung	z kanistra / of the canister / aus dem Kanister
Wymiary / dimensions / maße des Seifenspenders	160 x 105 x 85 mm



## SA650SHB

### Dozownik mydła w płynie 0,65l LAB / Liquid soap dispenser 0,65l LAB / Flüssigseifenspender 0,65l LAB

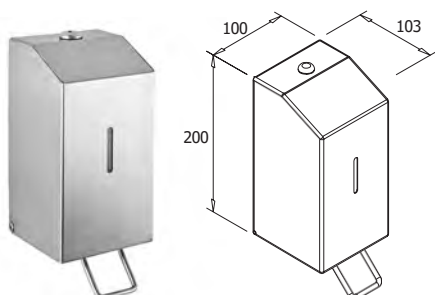

Materiał / material / werkstoff	stal nierdzewna 304 / 304 stainless steel / Edelstahl 304
Kolor / colour / farbe	mat / satin / Matt
Pojemność / capacity / fassungsvermögen	0,65l (650ml)
Napełnianie / filling / auffüllung	z kanistra / of the canister / aus dem Kanister
Wymiary / dimensions / maße des Seifenspenders	200 x 100 x 103 mm



## SA1001SHB

### Dozownik mydła w płynie i środków dezynfekcyjnych 1l LAB Liquid soap and disinfectant dispenser 1l LAB Spender für Flüssigseife und Desinfektionsmittel 1l LAB

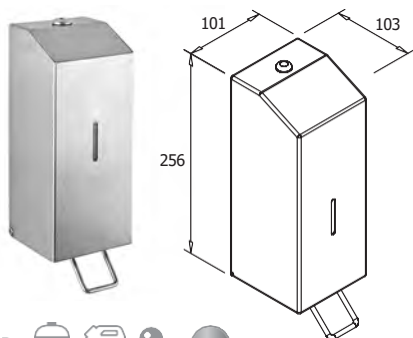

Materiał / material / werkstoff	stal nierdzewna 304 / 304 stainless steel / Edelstahl 304
Kolor / colour / farbe	mat / satin / Matt
Pojemność / capacity / fassungsvermögen	1l (1000ml)
Napełnianie / filling / auffüllung	z kanistra / of the canister / aus dem Kanister
Wymiary / dimensions / maße des Seifenspenders	256 x 101 x 103 mm



## SF1000SHB

### Dozownik mydła w pianie 1l LAB / Foam soap dispenser 1l LAB / Schaumseifenspender 1l LAB

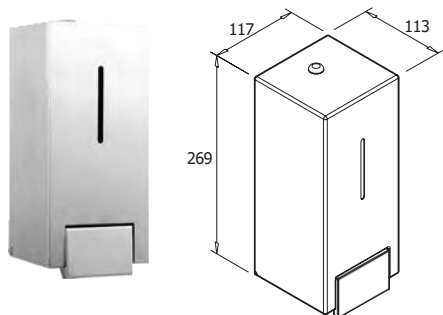

Materiał / material / werkstoff	stal nierdzewna 304 / 304 stainless steel / Edelstahl 304
Kolor / colour / farbe	mat / satin / Matt
Pojemność / capacity / fassungsvermögen	0,8l (800ml)
Napełnianie / filling / auffüllung	z kanistra / of the canister / aus dem Kanister
Wymiary / dimensions / maße des Seifenspenders	160 x 105 x 85 mm



## N03002.S

### Dozownik mydła w płynie poziomy 1,2l LAB Horizontal liquid soap dispenser 1,2l LAB Flüssigseifenspender horizontal 1,2l LAB

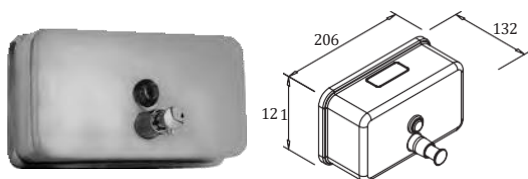

Materiał / material / werkstoff	stal nierdzewna 304 / 304 stainless steel / Edelstahl 304
Kolor / colour / farbe	mat / satin / Matt
Pojemność / capacity / fassungsvermögen	1,2l (1200ml)
Napełnianie / filling / auffüllung	z kanistra / of the canister / aus dem Kanister
Wymiary / dimensions / maße des Seifenspenders	121 x 210 x 70 mm



## S1200SDB

### Automatyczny dozownik mydła w płynie 1,2l LAB Automatic liquid soap dispenser 1,2l LAB Automatischer Flüssigseifenspender 1,2l LAB

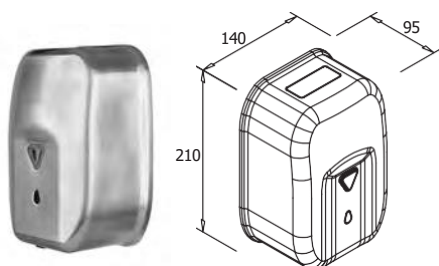

Materiał / material / werkstoff	stal nierdzewna 304 / 304 stainless steel / Edelstahl 304
Kolor / colour / farbe	mat / satin / Matt
Pojemność / capacity / fassungsvermögen	1,2l (1200ml)
Napełnianie / filling / auffüllung	z kanistra / of the canister / aus dem Kanister
Wymiary / dimensions / maße des Seifenspenders	210 x 140 x 95 mm



## ESA500

### Dozownik płynów dezynfekcyjnych i mydła w płynie łokciowy 0,5l Disinfectant dispenser 0,5l Armhebelspender für Desinfektionsmittel und Flüssigseife 0,5l

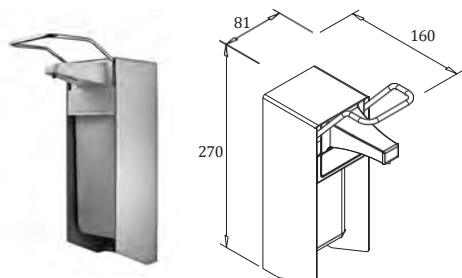

Materiał / material / werkstoff	plastik (pompa), aluminium (obudowa) / plastic (pomp), aluminium (housing) / Kunststoff (Pumpe), Aluminium (Gehäuse)
Kolor / colour / farbe	mat / satin / Matt
Pojemność / capacity / fassungsvermögen	0,5l (500ml)
Napełnianie / filling / auffüllung	z kanistra / of the canister / aus dem Kanister
Wymiary / dimensions / maße des Seifenspenders	270 x 81 x 160 mm



## ESA1001

### Dozownik płynów dezynfekcyjnych i mydła w płynie łokciowy 1l Disinfectant dispenser 1l Armhebelspender für Desinfektionsmittel und Flüssigseife 1l

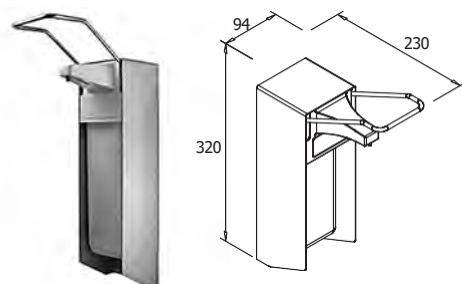

Materiał / material / werkstoff	Stal nierdzewna (pompa), aluminium (obudowa) / Stainless steel (pomp), aluminium (housing) / Edelstahl (Pumpe), Aluminium (Gehäuse)
Kolor / colour / farbe	mat / satin / Matt
Pojemność / capacity / fassungsvermögen	1l (1000ml)
Napełnianie / filling / auffüllung	z kanistra / of the canister / aus dem Kanister
Wymiary / dimensions / maße des Seifenspenders	320 x 94 x 160 mm





# Seria **COSMO** / **COSMO** Series / **COSMO**-Serie

---

Innowacyjna seria COSMO wykonana z polycarbonu - materiału cechującego się wysokimi właściwościami wandaloodpornymi. Serię COSMO wyróżnia nowoczesny design.

The innovative COSMO series is made of polycarbonate, a material that is highly vandal-proof. The COSMO series stands out owing to its modern design.

Innovative COSMO-Serie aus Polycarbonat, d. h. aus einem Material mit hoher Vandalismusbständigkeit. Die COSMO-Serie besticht durch modernes Design.

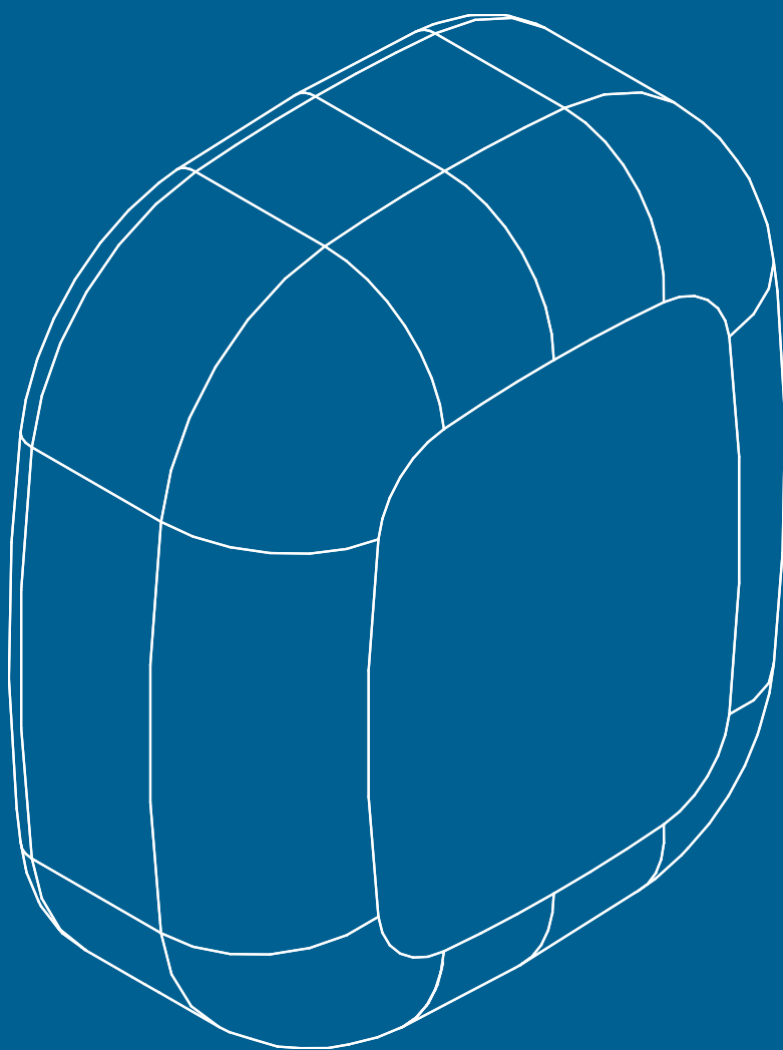

Wandaloodporny (trwały, mocny materiał) - polycarbon /  
Vandal-proof (durable, strong material) - polycarbonate /  
Vandalensicher (strapazierfähiges, robustes Material) - Polycarbonat



Innowacyjny design /  
Innovative design /  
Innovatives Design

Pojemnik na mydło oraz przejrzysta kontrola poziomu mydła /  
A soap container and a transparent soap level indicator /  
Seifenspender und transparente Seifenpegelkontrolle

Brak ostrych kątów - łatwy w czyszczeniu /  
No sharp edges - easy to clean /  
Keine scharfen Kanten - leicht zu reinigen

## LCJ5003B / LCJ5003BL

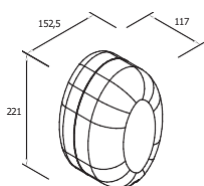

**Dozownik mydła w płynie 0,9l COSMO biały / czarny**  
**Liquid soap dispenser 0,9l COSMO white / black**  
**Flüssigseifenspender 0,9l COSMO weiß / schwarz**

Materiał / material / werkstoff	polycarbon / polycarbonate / polycarbonat
Kolor / colour / farbe	biały / czarny   white / black   weiß / schwarz
Pojemność / capacity / fassungsvermögen	0,9l (900ml)
Napełnianie / filling / auffüllung	z kanistra / of the canister / aus dem Kanister
Wymiary / dimensions / maße des Seifenspenders	221 x 152,5 x 117 mm

## LCJ5003B / LCJ5003BL

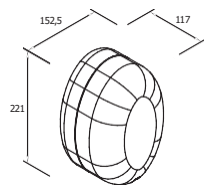

**Dozownik mydła w pianie 0,9l COSMO biały / czarny**  
**Foam soap dispenser 0,9l COSMO white / black**  
**Schaumseifenspender 0,9l COSMO weiß / schwarz**

Materiał / material / werkstoff	polycarbon / polycarbonate / polycarbonat
Kolor / colour / farbe	biały / czarny   white / black   weiß / schwarz
Pojemność / capacity / fassungsvermögen	0,9l (900ml)
Napełnianie / filling / auffüllung	z kanistra / of the canister / aus dem Kanister
Wymiary / dimensions / maße des Seifenspenders	221 x 152,5 x 117 mm

## LCJ5005B/LCJ5005BL



### Podajnik ręczników ZZ COSMO biały / czarny Paper towel dispenser 0,9l COSMO white / black Papiertuchspender ZZ COSMO weiß / schwarz

Materiał / material / werkstoff	policarbon / polycarbonate / polycarbonat
Kolor / colour / farbe	biały / czarny   white / black   weiß / schwarz
Pojemność / capacity / fassungsvermögen	600 listków / 600 towels / 600 papierblätter
Wymiary / dimensions / maße des Seifenspenders	374 x 325 x 146 mm

## LCP5010B

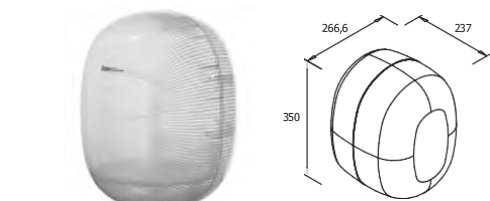

### Podajnik ręczników w roli COSMO biały Paper roll towel dispenser COSMO white Rollenpapiertuchspender COSMO weiß

Materiał / material / werkstoff	policarbon / polycarbonate / polycarbonat
Kolor / colour / farbe	biały / white / weiß
Pojemność / capacity / fassungsvermögen	rola o max Ø 20 cm i szerokości 21 cm / roll up to Ø 20 cm and width 21 cm / Rolle mit max. Ø 20 cm und Breite 21 cm
Wymiary / dimensions / maße des Seifenspenders	350 x 266,6 x 237mm

## LCP5006B / LCP5006BL



### Pojemnik na papier toaletowy COSMO biały / czarny Toilet paper dispenser COSMO white / black Toilettenpapierbehälter COSMO weiß / schwarz

Materiał / material / werkstoff	policarbon / polycarbonate / polycarbonat
Kolor / colour / farbe	biały / czarny   white / black   weiß / schwarz
Pojemność / capacity / fassungsvermögen	rola Ø 18 - 21 cm, trzpień 4,3 cm / roll Ø 18 - 21 cm, pin 4,3 cm / Rolle Ø 18 - 21 cm, Zapfen 4,3 cm
Wymiary / dimensions / maße des Seifenspenders	253 x 253 x 151 mm

## LCP5008BL

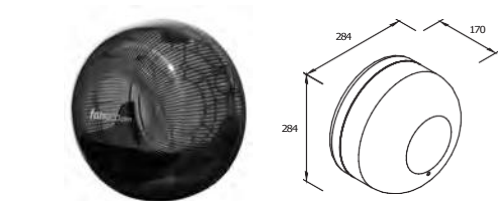

### Pojemnik na papier toaletowy COSMO czarny Toilet paper dispenser COSMO black Toilettenpapierbehälter COSMO Schwarz

Materiał / material / werkstoff	policarbon / polycarbonate / polycarbonat
Kolor / colour / farbe	czarny / black / schwarz
Pojemność / capacity / fassungsvermögen	rola Ø 20,1 cm / roll Ø 20,1 cm / Rolle Ø 20,1 cm
Wymiary / dimensions / maße des Seifenspenders	284 x 284 x 170 mm

## LCP5007B / LCP5007BL



### Pojemnik na papier toaletowy COSMO M biały / czarny Toilet paper dispenser COSMO M white / black Toilettenpapierbehälter COSMO M weiß / schwarz

Materiał / material / werkstoff	policarbon / polycarbonate / polycarbonat
Kolor / colour / farbe	biały / czarny   white / black   weiß / schwarz
Pojemność / capacity / fassungsvermögen	rola Ø 20,1 cm / roll Ø 20,1 cm / Rolle Ø 20,1 cm
Wymiary / dimensions / maße des Seifenspenders	284 x 284 x 170 mm

# Seria **LUNA** i **SOL** / **LUNA** and **SOL** series / **LUNA** und **SOL**-serie

---

Produkty wandaloodpornej serii LUNA i SOL cechuje wysoka jakość wykonania i nowoczesny design. Dostępne są w wykończeniu ze stali nierdzewnej matowej i polerowanej. Idealnie sprawdzą się w prestiżowych obiektach oraz miejscach narażonych na akty wandalizmu.

Vandal-proof LUNA and SOL series feature the high quality of manufacture and a modern design. They are available in stainless steel matt and polished versions. They match perfectly prestigious premises and sites that are exposed to acts of vandalism.

Die vandalensicheren Produkte aus der Serie LUNA und SOL zeichnen sich durch hohe Qualität und modernes Design aus. Sie sind mit mattem und poliertem Edelstahl erhältlich. Sie bewähren sich bestens in prestigeträchtigen Bauwerken und an Orten, die Vandalismus ausgesetzt sind.

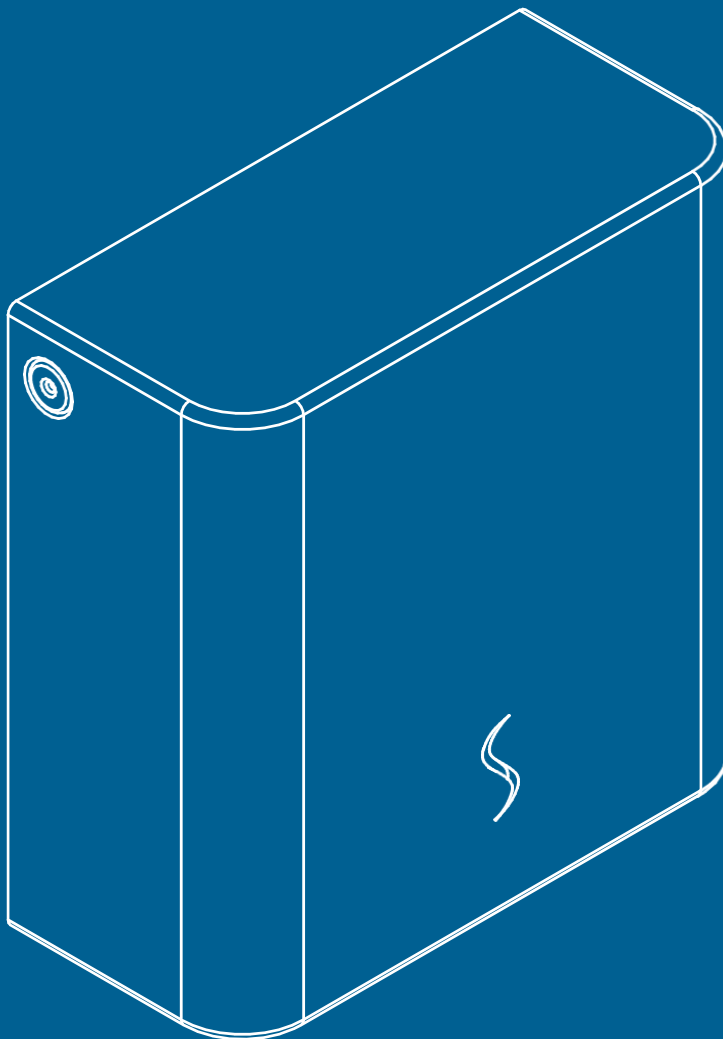

Dopracowane wykończenie krawędzi /  
Excellent finish of edges /  
Feine Endbearbeitung der Kanten

Solidne zamknięcie -  
zamek i klucz metalowy /  
Solid closure - a lock and a metal key /  
Solider Verschluss -  
Schloss und Metallschlüssel



Efektowny design /  
An excellent design /  
Effektvolles Design



Grubość stali 1mm /  
Steel, 1 mm thick /  
Stahlstärke 1 mm



Plastyczny pojemnik na mydło w płynie /  
A plastic liquid soap container /  
Kunststoffbehälter für Flüssigseife

## S900SNB / S900SNP

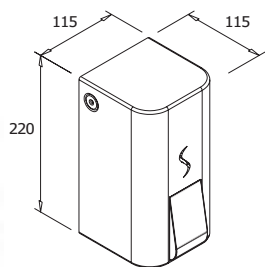

## Dozownik mydła w płynie 0,9l LUNA / SOL Liquid soap dispenser 0,9l LUNA / SOL Flüssigseifenspender 0,9l LUNA / SOL

Materiał / material / werkstoff	stal nierdzewna 304 / 304 stainless steel / Edelstahl 304
Kolor / colour / farbe	mat / połysk   satin / brilliance   Matt / Glänzend
Pojemność / capacity / fassungsvermögen	0,9l (900ml)
Napełnianie / filling / auffüllung	z kanistra / of the canister / aus dem Kanister
Wymiary / dimensions / maße des Seifenspenders	220 x 115 x 115 mm



## P600SNB / P600SNP

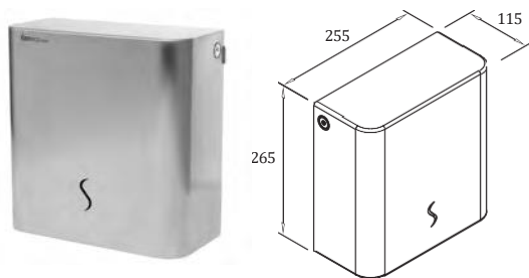

### Podajnik ręczników ZZ LUNA / SOL Paper towel dispenser LUNA / SOL Papiertuchspender ZZ LUNA / SOL

Materiał / material / werkstoff	stal nierdzewna 304 / 304 stainless steel / Edelstahl 304
Kolor / colour / farbe	mat / połysk   satin / brilliance   Matt / Glänzend
Pojemność / capacity / fassungsvermögen	600 listków / 600 towels / 600 papierblätter
Wymiary / dimensions / maße des Seifenspenders	265 x 255 x 115 mm



## J25SNB / J25SNP

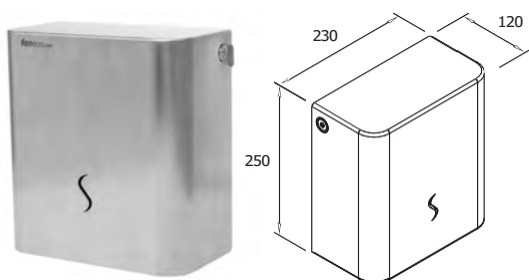

### Pojemnik na papier toaletowy LUNA / SOL Toilet paper dispenser LUNA / SOL Toilettenpapierbehälter LUNA / SOL

Materiał / material / werkstoff	stal nierdzewna 304 / 304 stainless steel / Edelstahl 304
Kolor / colour / farbe	mat / połysk   satin / brilliance   Matt / Glänzend
Pojemność / capacity / fassungsvermögen	rola Ø 19 cm, trzpień 5,6 cm / roll Ø 19 cm, pin 5,6 cm / Rolle Ø 19 cm, Zapfen 5,6 cm
Wymiary / dimensions / maße des Seifenspenders	250 x 230 x 120 mm



## WB28SNB / WB28SNP

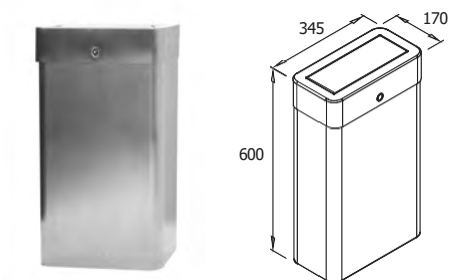

### Kosz z uchylną pokrywą 28l LUNA / SOL Wastepaper bin with swing lid LUNA / SOL Abfallbehälter mit Kippdeckel LUNA / SOL

Materiał / material / werkstoff	stal nierdzewna 304 / 304 stainless steel / Edelstahl 304
Kolor / colour / farbe	mat / połysk   satin / brilliance   Matt / Glänzend
Pojemność / capacity / fassungsvermögen	28l
Wymiary / dimensions / maße des Seifenspenders	600 x 345 x 170 mm



# Suszarki / Hand dryers / Händetrockner

---

Suszarki do rąk to doskonała alternatywa dla ręczników papierowych, są bowiem bardziej ekonomiczne w eksploatacji. Oferowane suszarki do rąk charakteryzują się eleganckim wzornictwem, spójnym z poszczególnymi liniami stylistycznymi pozostałych artykułów wyposażenia toalet.

Hand driers are an excellent alternative to paper towels, providing substantial savings in operation. The offered driers feature an elegant design that is consistent with stylistic lines of other toilet accessories.

Handtrockner gelten als eine hervorragende Alternative für Papiertücher, da sie nämlich viel sparsamer im Gebrauch sind. Die angebotenen Haartrockner zeichnen sich durch elegantes Design, welches mit den jeweiligen Stillinien der anderen Artikel der Toilettenausrüstung kompatibel ist.

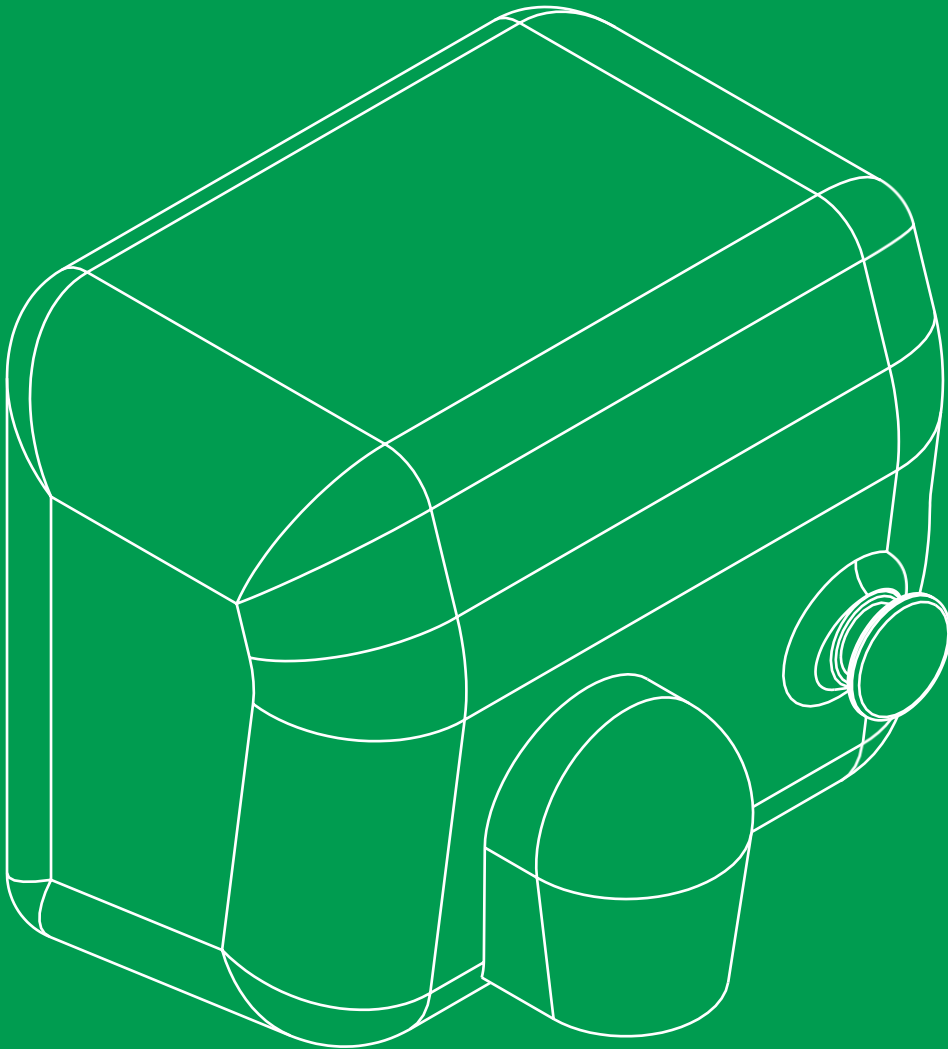



## D1200PCW

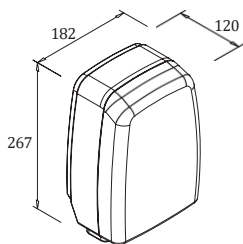

### Suszarka do rąk / Hand dryer / Handtrockner 1200W HALNY

Moc znamionowa / power / nennleistung	1200 W
Materiał / material / gehäusematerial	plastik ABS / plastic ABS / ABS-Kunststoff
Kolor / colour / farbe	biały / white / weiß
Sposób uruchamiania / launch / aktivierungsart	automatyczny / automatic / automatisch
Poziom hałasu / noise / geräuschpegel	70 dB
Napięcie zasilania / voltage / versorgungsspannung	220 – 240 V
Temperatura / drying temperature / trocknungstemperatur	60±15°C
Czas suszenia / drying time / trocknungszeit	40 s
Wymiary / dimensions / maße	267 x 182 x 120 mm

## D2000PLW

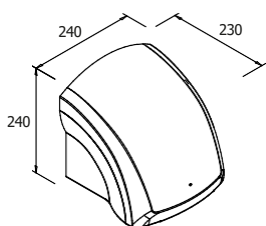

### Suszarka do rąk / Hand dryer / Handtrockner 2000W MISTRAL

Moc znamionowa / power / nennleistung	2000W
Materiał / material / gehäusematerial	plastik ABS / plastic ABS / ABS-Kunststoff
Kolor / colour / farbe	biały / white / weiß
Sposób uruchamiania / launch / aktivierungsart	automatyczny / automatic / automatisch
Poziom hałasu / noise / geräuschpegel	60 dB
Napięcie zasilania / voltage / versorgungsspannung	220 – 240 V
Temperatura / drying temperature / trocknungstemperatur	50°C
Czas suszenia / drying time / trocknungszeit	25 s
Wymiary / dimensions / maße	240 x 240 x 230 mm

## D2300PFG

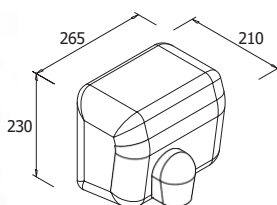

### Suszarka do rąk / Hand dryer / Handtrockner 2300W PONENTE

Moc znamionowa / power / nennleistung	2300W
Materiał / material / gehäusematerial	plastik ABS / plastic ABS / ABS-Kunststoff
Kolor / colour / farbe	srebrny / silver / silber
Sposób uruchamiania / launch / aktivierungsart	automatyczny / automatic / automatisch
Poziom hałasu / noise / geräuschpegel	70 dB
Napięcie zasilania / voltage / versorgungsspannung	220 – 240 V
Temperatura / drying temperature / trocknungstemperatur	45 - 70 °C
Czas suszenia / drying time / trocknungszeit	15 - 20 s
Wymiary / dimensions / maße	230 x 265 x 210 mm

## D1650SIB

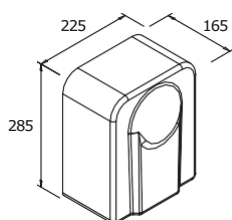

### Suszarka do rąk / Hand dryer / Handtrockner 1650 W LEVANTE

Moc znamionowa / power / nennleistung	1650W
Materiał / material / gehäusematerial	stal nierdzewna / stainless steel / Edelstahl
Kolor / colour / farbe	mat / satin / Matt
Sposób uruchamiania / launch / aktivierungsart	automatyczny / automatic / automatisch
Poziom hałasu / noise / geräuschpegel	60 dB
Napięcie zasilania / voltage / versorgungsspannung	220 – 240 V
Temperatura / drying temperature / trocknungstemperatur	50 °C
Czas suszenia / drying time / trocknungszeit	30 - 40 s
Wymiary / dimensions / maße	285 x 225 x 165 mm

## D1350SCBH

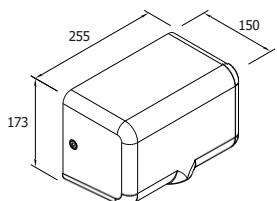

### Suszarka do rąk / Hand dryer / Handtrockner 1350 W PASSAT H

Moc znamionowa / power / nennleistung	1350W
Materiał / material / gehäusematerial	stal nierdzewna / stainless steel / Edelstahl
Kolor / colour / farbe	mat / satin / Matt
Sposób uruchamiania / launch / aktivierungsart	automatyczny / automatic / automatisch
Poziom hałasu / noise / geräuschpegel	70 dB
Napięcie zasilania / voltage / versorgungsspannung	220 – 240 V
Temperatura / drying temperature / trocknungstemperatur	40 °C
Czas suszenia / drying time / trocknungszeit	10 - 12 s
Wymiary / dimensions / maße	173 x 255 x 150 mm



## D1350SCB

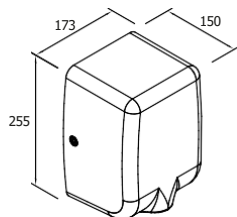

### Suszarka do rąk / Hand dryer / Handtrockner 1350 W PASSAT V

Moc znamionowa / power / nennleistung	1350W
Materiał / material / gehäusematerial	stal nierdzewna / stainless steel / Edelstahl
Kolor / colour / farbe	mat / satin / Matt
Sposób uruchamiania / launch / aktivierungsart	automatyczny / automatic / automatisch
Poziom hałasu / noise / geräuschpegel	70 dB
Napięcie zasilania / voltage / versorgungsspannung	220 – 240 V
Temperatura / drying temperature / trocknungstemperatur	40 °C
Czas suszenia / drying time / trocknungszeit	10 - 12 s
Wymiary / dimensions / maße	255 x 173 x 150 mm

## D2100SCB

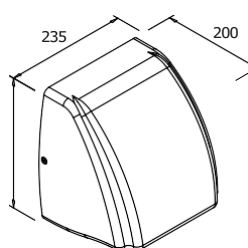

### Suszarka do rąk / Hand dryer / Handtrockner 2100 W LESTE

Moc znamionowa / power / nennleistung	2100W
Materiał / material / gehäusematerial	stal nierdzewna / stainless steel / Edelstahl
Kolor / colour / farbe	mat / satin / Matt
Sposób uruchamiania / launch / aktivierungsart	automatyczny / automatic / automatisch
Poziom hałasu / noise / geräuschpegel	65 dB
Napięcie zasilania / voltage / versorgungsspannung	220 – 240 V
Temperatura / drying temperature / trocknungstemperatur	50 °C
Czas suszenia / drying time / trocknungszeit	20 - 25 s
Wymiary / dimensions / maße	265 x 235 x 200 mm

## D2100SCP

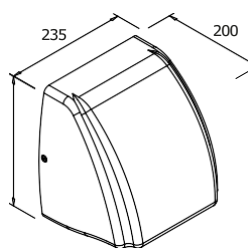

### Suszarka do rąk / Hand dryer / Handtrockner 2100 W SANTANA

Moc znamionowa / power / nennleistung	2100W
Materiał / material / gehäusematerial	stal nierdzewna / stainless steel / Edelstahl
Kolor / colour / farbe	polysk / brilliance / Glänzend
Sposób uruchamiania / launch / aktivierungsart	automatyczny / automatic / automatisch
Poziom hałasu / noise / geräuschpegel	65 dB
Napięcie zasilania / voltage / versorgungsspannung	220 V
Temperatura / drying temperature / trocknungstemperatur	50 °C
Czas suszenia / drying time / trocknungszeit	20 - 25 s
Wymiary / dimensions / maße	265 x 235 x 200 mm

## D2500SDB

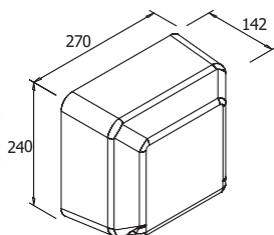

### Suszarka do rąk / Hand dryer / Handtrockner 2500W ZONDA

Moc znamionowa / power / nennleistung	2500W
Materiał / material / gehäusematerial	stal nierdzewna / stainless steel / Edelstahl
Kolor / colour / farbe	mat / satin / Matt
Sposób uruchamiania / launch / aktivierungsart	automatyczny / automatic / automatisch
Poziom hałasu / noise / geräuschpegel	70 dB
Napięcie zasilania / voltage / versorgungsspannung	220 - 240 V
Temperatura / drying temperature / trocknungstemperatur	60±15°C
Czas suszenia / drying time / trocknungszeit	15 s
Wymiary / dimensions / maße	240 x 270 x 142 mm

## DA2500SFB

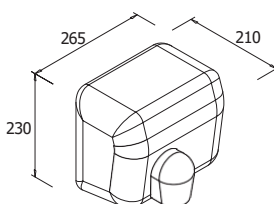

### Suszarka do rąk / Hand dryer / Handtrockner 2500W SOLANO

Moc znamionowa / power / nennleistung	2500W
Materiał / material / gehäusematerial	stal nierdzewna / stainless steel / Edelstahl
Kolor / colour / farbe	mat / satin / Matt
Sposób uruchamiania / launch / aktivierungsart	automatyczny / automatic / automatisch
Poziom hałasu / noise / geräuschpegel	70 dB
Napięcie zasilania / voltage / versorgungsspannung	220 - 240 V
Temperatura / drying temperature / trocknungstemperatur	50 °C
Czas suszenia / drying time / trocknungszeit	15 – 20 s
Wymiary / dimensions / maße	237 x 270 x 208 mm

## DP2500SFB

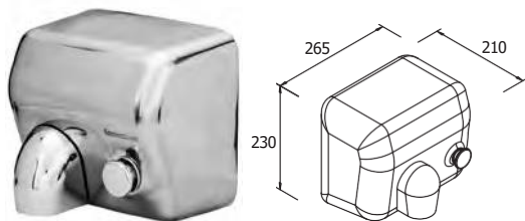

### Suszarka do rąk / Hand dryer / Handtrockner 2500W SIROCCO

Moc znamionowa / power / nennleistung	2500W
Materiał / material / gehäusematerial	stal nierdzewna / stainless steel / Edelstahl
Kolor / colour / farbe	mat / satin / Matt
Sposób uruchamiania / launch / aktivierungsart	przycisk / button / taste
Poziom hałasu / noise / geräuschpegel	70 dB
Napięcie zasilania / voltage / versorgungsspannung	220 – 240 V
Temperatura / drying temperature / trocknungstemperatur	50 °C
Czas suszenia / drying time / trocknungszeit	15 – 20 s
Wymiary / dimensions / maße	237 x 270 x 208 mm

## M32052TC

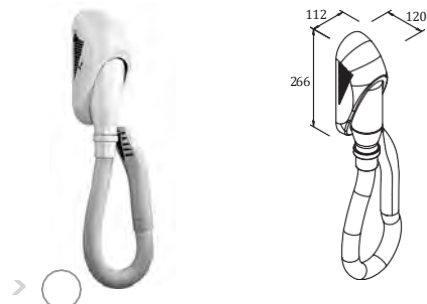

### Suszarka do włosów / Hair dryer / Haartrockner 700W ZEFIR

Moc znamionowa / power / nennleistung	700W
Materiał / material / gehäusematerial	plastik ABS / plastic ABS / ABS-Kunststoff
Kolor / colour / farbe	biały / white / weiß
Sposób uruchamiania / launch / aktivierungsart	Zdjąć i pociągnąć uchwyt / To pull a handle / Abnehmen und am Griff ziehen
Napięcie zasilania / voltage / versorgungsspannung	230 V
Wymiary / dimensions / maße	265 x 112 x 120 mm

## HD1000PLW1

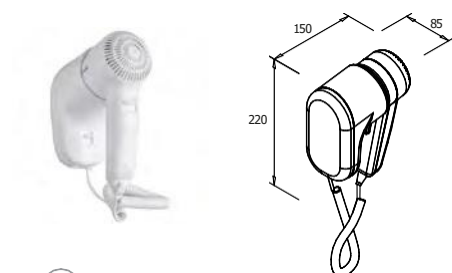

### Suszarka do włosów / Hair dryer / Haartrockner 1000W JUGA

Moc znamionowa / power / nennleistung	1000W
Materiał / material / gehäusematerial	plastik ABS / plastic ABS / ABS-Kunststoff
Kolor / colour / farbe	biały / white / weiß
Sposób uruchamiania / launch / aktivierungsart	przycisk / button / taste
Napięcie zasilania / voltage / versorgungsspannung	220 V
Wymiary / dimensions / maße	220 x 150 x 85 mm

## HD1200PLW2 / B2

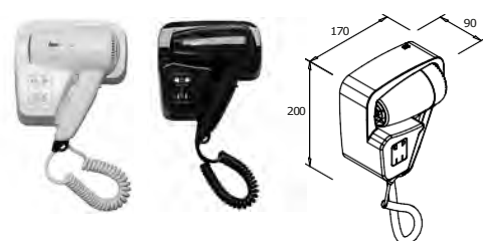

### Suszarka do włosów / Hair dryer / Haartrockner 1200W FEN

Moc znamionowa / power / nennleistung	1200W
Materiał / material / gehäusematerial	plastik ABS / plastic ABS / ABS-Kunststoff
Kolor / colour / farbe	biały / white / weiß   czarny / black / schwarz
Sposób uruchamiania / launch / aktivierungsart	przycisk / button / taste
Napięcie zasilania / voltage / versorgungsspannung	220 V
Wymiary / dimensions / maße	200 x 170 x 90 mm

# Suszarki kieszeniowe / Jet hand dryers / Tasche-Händetrockner

---

To nowoczesne rozwiązanie, które jest alternatywą dla tradycyjnych suszarek. Umożliwiają one szybkie suszenie rąk, nawet w kilka sekund. Suszenie polega na zdmuchiwaniu wody z dłoni strumieniem powietrza o dużej prędkości.

This modern solution is an alternative to traditional driers. They make it possible to dry your hands quickly. Water is blown off your hands with a high speed air jet.

Dies ist eine moderne Lösung, die als Alternative für herkömmliche Trockner fungiert. Sie ermöglichen blitzschnelles Trocknen von Händen in wenigen Sekunden. Beim Trocknen wird das Wasser aus der Handfläche mit einem Luftstrahl mit hoher Geschwindigkeit ausgeblasen.

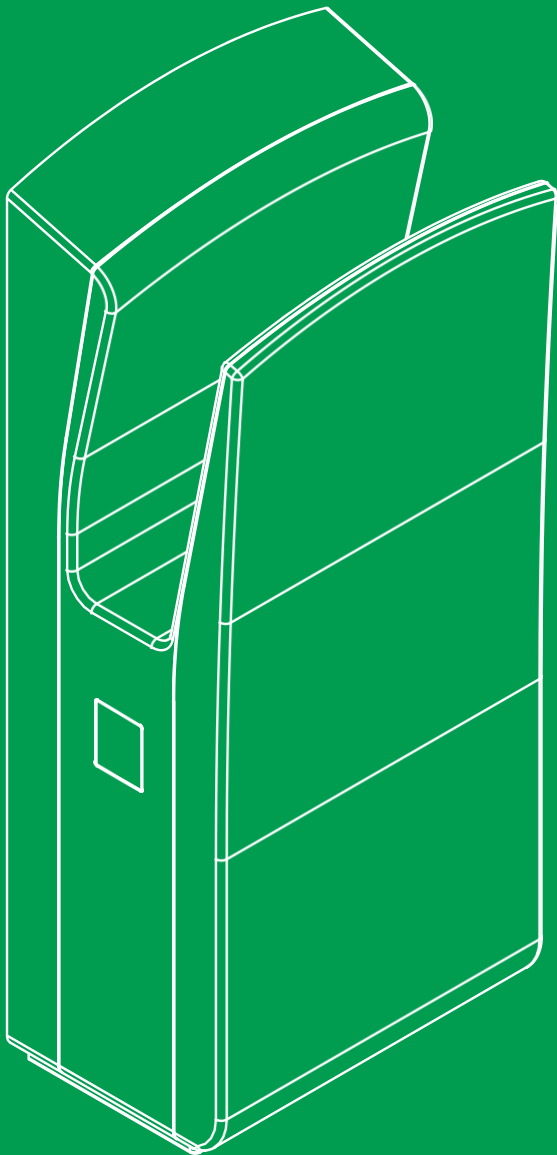

## DA1650PFW

### Suszarka kieszeniowa / Jet hand dryer / Tasche-handetrockner 1650 W MONSUN

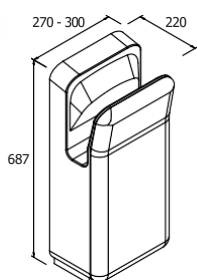

Moc znamionowa / power / nennleistung	1650 W
Materiał / material / gehäusematerial	plastik ABS / plastic ABS / ABS-Kunststoff
Kolor / colour / farbe	biały / white / weiß
Typ silnika / motor type / motortyp	szczotkowy / brush / bürstenmotor
Sposób uruchamiania / launch / aktivierungsart	automatyczny / automatic / automatisch
Poziom hałasu / noise / geräuschpegel	73 dB
Napięcie zasilania / voltage / versorgungsspannung	220 – 240 V
Temperatura / drying temperature / trocknungstemperatur	35 °C
Czas suszenia / drying time / trocknungszeit	7-10 s
Wymiary / dimensions / maße	687 x 270-300 x 220 mm



## DA1650PFS

### Suszarka kieszeniowa / Jet hand dryer / Tasche-handetrockner 1650 W MONSUN

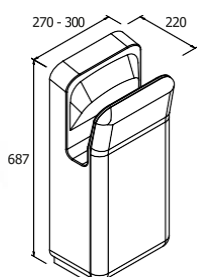

Moc znamionowa / power / nennleistung	1650 W
Materiał / material / gehäusematerial	plastik ABS / plastic ABS / ABS-Kunststoff
Kolor / colour / farbe	silver / silber
Typ silnika / motor type / motortyp	szczotkowy / brush / bürstenmotor
Sposób uruchamiania / launch / aktivierungsart	automatyczny / automatic / automatisch
Poziom hałasu / noise / geräuschpegel	73 dB
Napięcie zasilania / voltage / versorgungsspannung	220 – 240 V
Temperatura / drying temperature / trocknungstemperatur	35 °C
Czas suszenia / drying time / trocknungszeit	7-10 s



## DA1650SFB

### Suszarka kieszeniowa / Jet hand dryer / Tasche-handetrockner 1650 W MONSUN

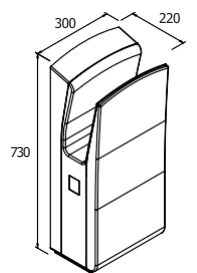

Moc znamionowa / power / nennleistung	1650 W
Materiał / material / gehäusematerial	Stal nierdzewna / stainless steel / Edelstahl
Kolor / colour / farbe	mat / satin / Matt
Typ silnika / motor type / motortyp	szczotkowy / brush / bürstenmotor
Sposób uruchamiania / launch / aktivierungsart	automatyczny / automatic / automatisch
Poziom hałasu / noise / geräuschpegel	70 dB
Napięcie zasilania / voltage / versorgungsspannung	230 V
Temperatura / drying temperature / trocknungstemperatur	40 °C
Czas suszenia / drying time / trocknungszeit	5-7 s
Wymiary / dimensions / maße	730 x 300 x 220 mm



## DA1800PKWG

### Suszarka kieszeniowa / Jet hand dryer / Tasche-handetrockner 1800 W MONSUN

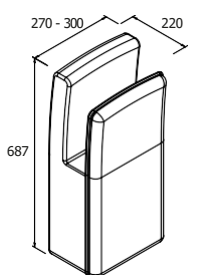

Moc znamionowa / power / nennleistung	1800W
Materiał / material / gehäusematerial	plastik ABS / plastic ABS / ABS-Kunststoff
Kolor / colour / farbe	biały / white / weiß
Typ silnika / motor type / motortyp	bezzszczotkowy / brushless / bürstenloser motor
Sposób uruchamiania / launch / aktivierungsart	automatyczny / automatic / automatisch
Poziom hałasu / noise / geräuschpegel	73 dB
Napięcie zasilania / voltage / versorgungsspannung	220 – 240 V
Temperatura / drying temperature / trocknungstemperatur	35 °C
Czas suszenia / drying time / trocknungszeit	7-10 s
Wymiary / dimensions / maße	687 x 270-300 x 220 mm



## AB14W

### Suszarka kieszeniowa / Jet hand dryer / Tasche-handetrockner 1600 W DYSON Airblade

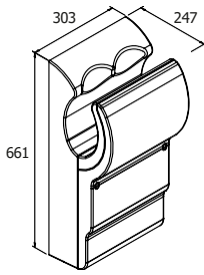

Moc znamionowa / power / nennleistung	1600 W
Materiał / material / gehäusematerial	poliwęglan - ABS / polycarbonate - ABS/ Polycarbonat - ABS
Kolor / colour / farbe	biały / white / weiß
Sposób uruchamiania / launch / aktivierungsart	automatyczny / automatic / automatisch
Poziom hałasu / noise / geräuschpegel	81 dB
Napięcie zasilania / voltage / versorgungsspannung	220 – 240 V
Temperatura / drying temperature / trocknungstemperatur	35 °C
Czas suszenia / drying time / trocknungszeit	10 s
Wymiary / dimensions / maße	661 x 303 x 247 mm



## AB14G

### Suszarka kieszeniowa / Jet hand dryer / Tasche-handetrockner 1600 W DYSON Airblade

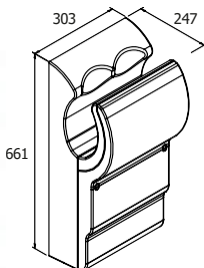

Moc znamionowa / power / nennleistung	1600 W
Materiał / material / gehäusematerial	poliwęglan - ABS / polycarbonate - ABS/ Polycarbonat - ABS
Kolor / colour / farbe	szary / grey / grau
Sposób uruchamiania / launch / aktivierungsart	automatyczny / automatic / automatisch
Poziom hałasu / noise / geräuschpegel	81 dB
Napięcie zasilania / voltage / versorgungsspannung	220 – 240 V
Temperatura / drying temperature / trocknungstemperatur	35 °C
Czas suszenia / drying time / trocknungszeit	10 s
Wymiary / dimensions / maße	661 x 303 x 247 mm



# Sanitariaty / Sanitary appliances / Sanitäreanlagen

---

Sanitariaty ze stali nierdzewnej wyróżniają się wyjątkową wytrzymałością. Misy WC czy też pisuary ze stali znajdują swoje zastosowanie w toaletach o wysokim przepływie użytkowników oraz w miejscach narażonych na akty wandalizmu, takich jak dworce, obiekty sportowe czy zakłady penitencjarne.

Toilets made of stainless steel stand out owing to their exceptional endurance. Toilet bowls and urinals made of steel prove excellent at high traffic toilets and in locations that are exposed to acts of vandalism, such as railway stations, sport facilities, and prisons.

Sanitäreanlagen aus Edelstahl bestechen durch extreme Robustheit. Toilettenschüssel und Urinale aus Stahl kommen auch in Toiletten mit hohem Auffkommen und in Vandalismus ausgesetzten Orten wie Bahnhöfe, Sportanlagen und Zuchthäuser zum Einsatz

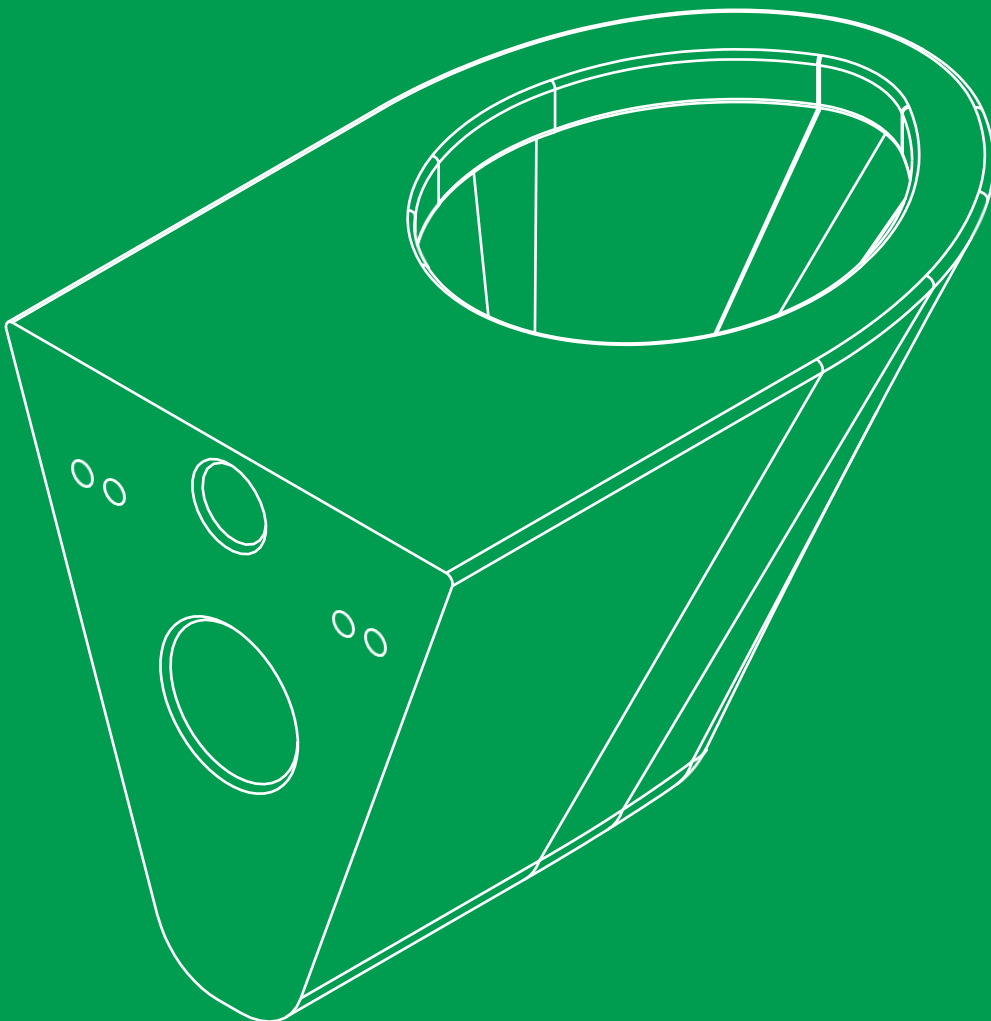

## N13018

### Miska WC wisząca ze stali nierdzewnej / Stainless steel wall-mounted toilet / Toilettenschüssel hängend aus Edelstahl

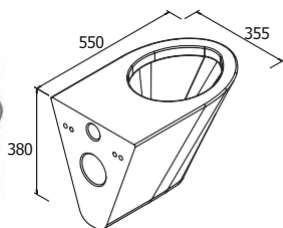

Materiał / material / werkstoff	stal nierdzewna 304 / stainless steel 304 / Edelstahl 304
Kolor / colour / farbe	matowe lub połysk / satin or brilliance / Matt oder glänzend
Wymiary / dimensions / maße des Seifenspenders	380 x 355 x 550 mm
Średnica odpływu / outlet diameter / abflussdurchmesser	Ø 104 mm
Grubość stali / steel thickness / stahlstärke	1 mm / 1,5 mm / 2 mm



## N13012

### Miska WC stojąca ze stali nierdzewnej / Stainless steel toilet, floor settled / Toilettenschüssel stehend aus Edelstahl

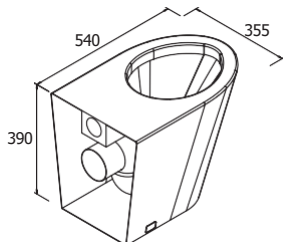

Materiał / material / werkstoff	stal nierdzewna 304 / stainless steel 304 / Edelstahl 304
Kolor / colour / farbe	matowe lub połysk / satin or brilliance / Matt oder glänzend
Wymiary / dimensions / maße des Seifenspenders	390 x 355 x 600 / 540 mm
Średnica odpływu / outlet diameter / abflussdurchmesser	Ø 100 mm
Grubość stali / steel thickness / stahlstärke	1,2 mm



## URT207

### Miska ustępową dla niepełnosprawnych ze stali nierdzewnej / Stainless steel toilet pan for disabled / Toilettenschüssel hängend für Behinderte aus Edelstahl

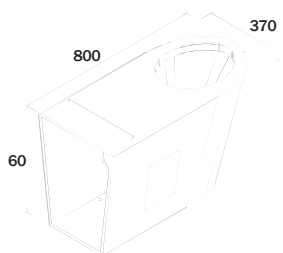

Materiał / material / werkstoff	stal nierdzewna 304 / stainless steel 304 / Edelstahl 304
Kolor / colour / farbe	matowe lub połysk / satin or brilliance / Matt oder glänzend
Wymiary / dimensions / maße des Seifenspenders	460 x 370 x 800 mm
Średnica odpływu / outlet diameter / abflussdurchmesser	Ø 104 mm
Grubość stali / steel thickness / stahlstärke	1 mm / 1,5 mm / 2 mm



## UR2A

### KOMPAKT WC stojący ze stali nierdzewnej z deską PVC / Stainless steel compact toilet with PVC seat, floor settled / KOMPAKTES WC stehend aus Edelstahl mit PVC-Sitz

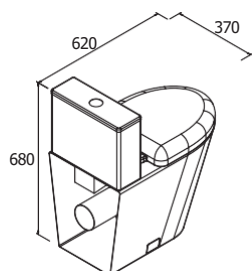

Materiał / material / werkstoff	stal nierdzewna 304 szcztokowana (miska), tworzywo PVC (deska) / stainless steel 304 brushed (toilet), PVC (seat) / Edelstahl 304 gebürstet (Schüssel), PVC-Werkstoff (Sitz)
Kolor / colour / farbe	mat (miska), biały (deska) / satin (toilet), white (seat) / Matt (Schüssel), weiß (Sitz)
Wymiary / dimensions / maße des Seifenspenders	680 x 370 x 620 mm
Średnica odpływu / outlet diameter / abflussdurchmesser	Ø 100 mm
Grubość stali / steel thickness / stahlstärke	1,2 mm / 2 mm



## N13124 (L/R)

### Zestaw: kompakt WC z umywalką (lewy/prawy) / Stainless steel set: toilet + washbasin (left/right) / Sanitäranlage: Schüssel + Waschbecken (links /rechts)

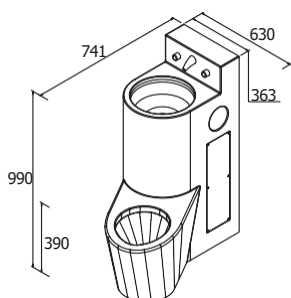

Materiał / material / werkstoff	stal nierdzewna 304 / stainless steel 304 / Edelstahl 304
Kolor / colour / farbe	mat / satin / Matt
Wymiary / dimensions / maße des Seifenspenders	990 x 630 x 741 mm
Średnica odpływu / outlet diameter / abflussdurchmesser	Ø 60 / Ø 100 mm
Grubość stali / steel thickness / stahlstärke	1 mm / 1,5 mm / 2 mm





## N13004

### Pisuar wiszący ze stali nierdzewnej / Stainless steel wall-mounted urinal / Pissoir hängend aus Edelstahl

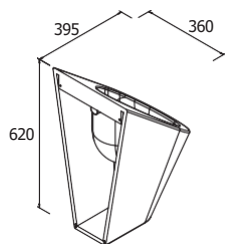

Materiał / material / werkstoff	stal nierdzewna 304 / stainless steel 304 / Edelstahl 304
Kolor / colour / farbe	matowe lub połysk / satin or brilliance / Matt oder glänzend
Wymiary / dimensions / maße des Seifenspenders	605 x 360 x 395 mm
Średnica odpływu / outlet diameter / abflussdurchmesser	Ø 100 mm
Grubość stali / steel thickness / stahlstärke	1,2 mm



## UR6

### Miska ustępowa turecka ze stali nierdzewnej / Stainless steel squatting WC / Türkische Toilettenschüssel aus Edelstahl

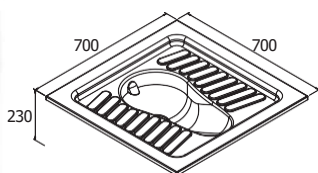

Materiał / material / werkstoff	stal nierdzewna 304 / stainless steel 304 / Edelstahl 304
Kolor / colour / farbe	mat / satin / Matt
Wymiary / dimensions / maße des Seifenspenders	230 x 700 x 700 mm
Średnica odpływu / outlet diameter / abflussdurchmesser	Ø 100 mm
Grubość stali / steel thickness / stahlstärke	1,2 mm



## SDWC01

### Stelaż podtynkowy do miski WC / Flush-mounted frame for toilet / Unterputzgestell für Toilettenschüsseln

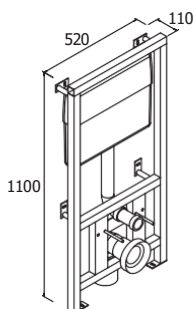

Materiał / material / werkstoff	stal malowana proszkowo / laquered steel / Pulverbeschichteter Stahl
Wymiary / dimensions / maße des Seifenspenders	1100 x 520 x 110 mm
Grubość stali / steel thickness / stahlstärke	1,5 mm
Przekrój profilu / profile section / profilquerschnitt	35 mm x 35 mm
Zbiornik / tank / behälter	6l
Aprobata techniczna / technical approval / technische Zulassung	COBRI INSTAL Nr. AT/2005-02-1548



## SDPC02

### Stelaż podtynkowy do pisuaru / Flush-mounted frame for urinal / Unterputzgestell für Pissoirs

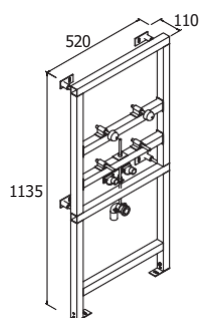

Materiał / material / werkstoff	stal malowana proszkowo / laquered steel / Pulverbeschichteter Stahl
Wymiary / dimensions / maße des Seifenspenders	1135 x 520 x 110 mm
Grubość stali / steel thickness / stahlstärke	1,5 mm
Przekrój profilu / profile section / profilquerschnitt	35 mm x 35 mm
Zbiornik / tank / behälter	6l
Aprobata techniczna / technical approval / technische Zulassung	COBRI INSTAL Nr. AT/2005-02-1548



## M13018 (B/W)

### Deska sedesowa kompozytowa (czarna/biała) Composite toilet seat (black/white) Toilettensitz aus einem Verbundstoff (Schwarz/weiß)

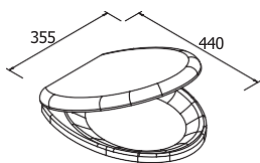

Materiał / material / werkstoff	kompozyt lakierowany (deska), metal (zawias) / lacquered composite (seat), metal (hinge) / Lackierter Verbundstoff (Brett), Metall (Scharnier)
Kolor / colour / farbe	czarna lub biała / black or white / Schwarz oder weiß
Wymiary / dimensions / maße des Seifenspenders	60 x 355 x 440 mm





## N13008.S

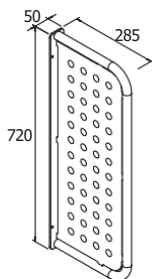

### Przegroda międzypisuarowa, perforowana / Urinal partition, perforated / Pissoir-Trennplatte, perforiert

Materiał / material / werkstoff	stal nierdzewna 304 / stainless steel 304 / Edelstahl 304
Kolor / colour / farbe	mat / satin / Matt
Wymiary / dimensions / maße des Seifenspenders	720 x 50 x 285 mm
Mocowanie / mounting / befestigung	do ściany / wall-mounted / Zur Wand

## N08071

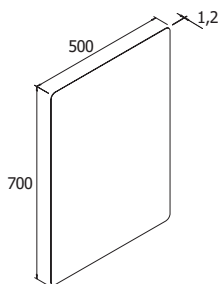

### Lustro stalowe dla zakładów karnych / Stainless steel mirror for prisons / Stahlspiegel für Strafvollzugsanstalten

Materiał / material / werkstoff	stal nierdzewna 304 / stainless steel 304 / Edelstahl 304
Kolor / colour / farbe	połysk / brilliance / Glänzend
Wymiary / dimensions / maße des Seifenspenders	700 x 500 mm
Mocowanie / mounting / befestigung	do ściany / wall-mounted / Zur Wand
Grubość stali / steel thickness / stahlstärke	1,2 mm

# Umywalki / Washbasins / Waschbecken

---

Umywalki ze stali szlachetnej charakteryzuje nie tylko wysoka odporność na zniszczenie ale również niebanalny wygląd. Posiadają bogactwo kształtów i rozmiarów, co pozwala na ich idealne dopasowanie do każdego pomieszczenia toalety publicznej.

Washbasins made of stainless steel feature high resistance to destruction. Their appearance is also far from ordinary. They come in a variety of shapes and sizes, which makes them fit perfectly any public toilet facility.

Die Waschbecken aus Edelstahl zeichnen sich nicht nur durch enorme Beständigkeit gegen Zerstörung, aber auch durch originelles Aussehen aus. Sie weisen eine Fülle an Formen und Größen auf, wodurch sie in jeden öffentlichen Toilettenraum bestens passen.

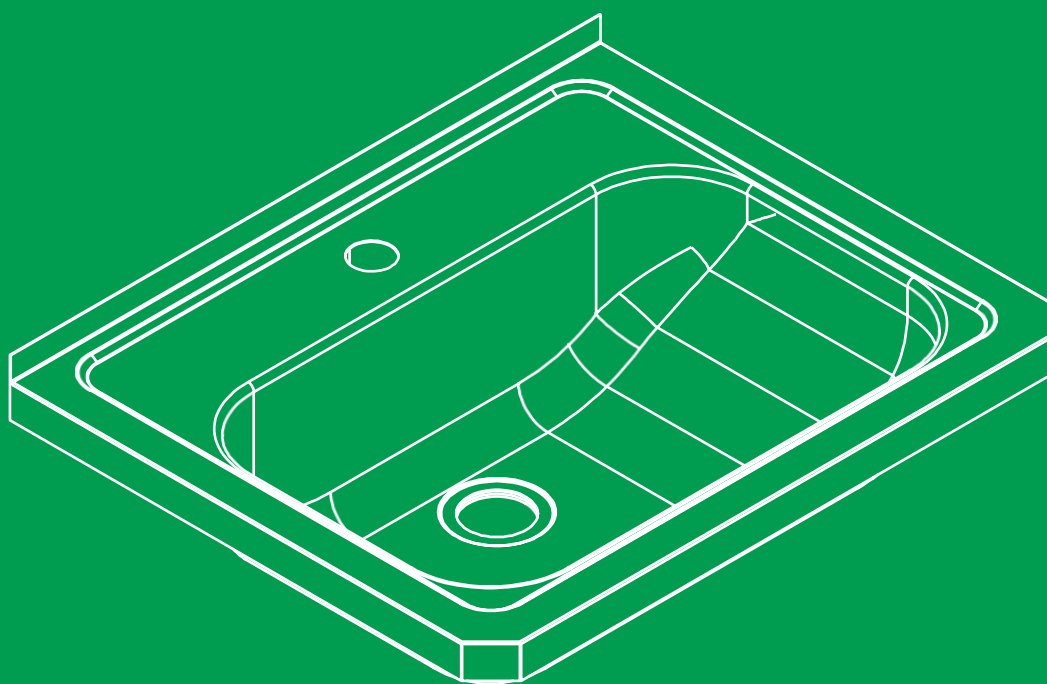

## IRS72

### Umywalka ścienna z otworem na baterię / Wall-mounted washbasin with faucet hole / Wandwaschbecken mit Armaturenöffnung

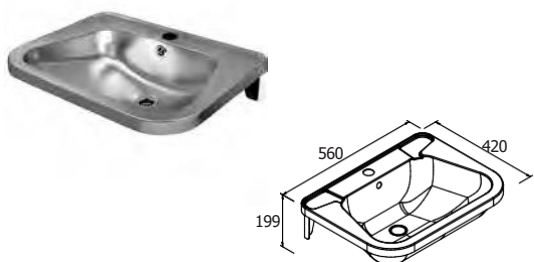

Materiał / material / werkstoff	stal nierdzewna 304 / stainless steel 304 / Edelstahl 304
Kolor / colour / farbe	mat / satin / Matt
Wymiary / dimensions / maße des Seifenspenders	199 x 560 x 420 mm
Średnica odpływu / outlet diameter / abflussdurchmesser	Ø 1 ¼ cala
Grubość stali / steel thickness / stahlstärke	0,9 mm



## L130200

### Umywalka ścienna dla niepełnosprawnych / Wall-mounted washbasin for disabled / Wandwaschbecken für Behinderte

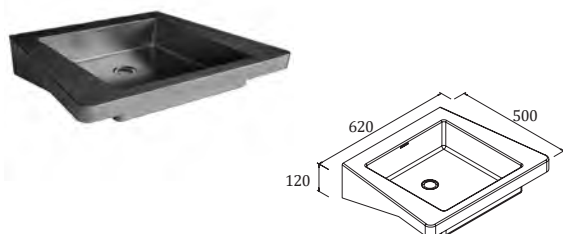

Materiał / material / werkstoff	stal nierdzewna 304 / stainless steel 304 / Edelstahl 304
Kolor / colour / farbe	mat / satin / Matt
Wymiary / dimensions / maße des Seifenspenders	120 x 620 x 500 mm



## N13030

### Umywalka ze stali nierdzewnej / Stainless steel washbasin / Waschbecken aus Edelstahl

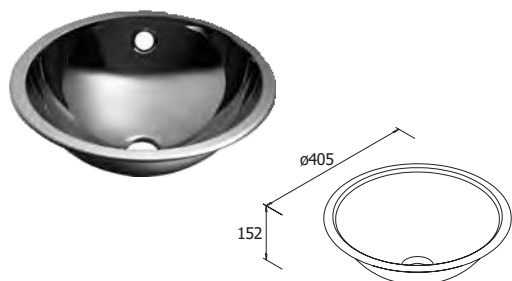

Materiał / material / werkstoff	stal nierdzewna 304 / stainless steel 304 / Edelstahl 304
Kolor / colour / farbe	matowe lub połysk / satin or brilliance / Matt oder glänzend
Wymiary / dimensions / maße des Seifenspenders	Ø 405 x 152 mm
t	Ø 50 mm
Grubość stali / steel thickness / stahlstärke	0,8 mm



## N13036.C.S

### Umywalka z osłoną na syfon / Washbasin with hidden siphon / Waschbecken aus Edelstahl

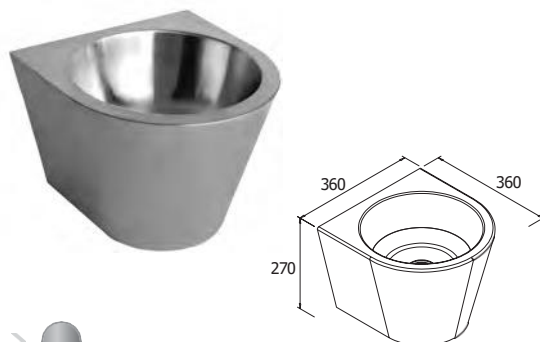

Materiał / material / werkstoff	stal nierdzewna 304 / stainless steel 304 / Edelstahl 304
Kolor / colour / farbe	mat / satin / Matt
Wymiary / dimensions / maße des Seifenspenders	Ø 360 x 270 mm
Średnica odpływu / outlet diameter / abflussdurchmesser	Ø 50 mm
Grubość stali / steel thickness / stahlstärke	0,8 mm



## N13050.06.S

## Umywalka ze stali nierdzewnej wielostanowiskowa / collective washbasin / kollektiv waschbecken

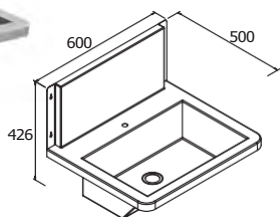

Materiał / material / werkstoff	stal nierdzewna 304 / stainless steel 304 / Edelstahl 304
Kolor / colour / farbe	mat / satin / Matt
Wymiary / dimensions / maße des Seifenspenders	426 x 600/1200/1800/2400/3000 x 500 mm
Średnica odpływu / outlet diameter / abflussdurchmesser	Ø 50 mm
Grubość stali / steel thickness / stahlstärke	0,8 mm





# Przewijaki / Baby changing stations / Babywickeltische

Bogata oferta stanowisk do przewijania dzieci i niemowląt o solidnej i zarazem wygodnej w użytkowaniu konstrukcji. To produkty wysoce funkcjonalne, wykonane z wytrzymałych tworzyw spełniające wszelkie standardy bezpieczeństwa.

A rich offer of changing tables for children and infants features a solid and comfortable structure. These products are highly functional, made of durable plastic that meets all safety standards.

Große Auswahl an Kinder- und Baby-Wickelstationen mit solider und zugleich gebrauchsbekommener Konstruktion. Dies sind enorm praktische Produkte, die aus robusten Kunststoffen gefertigt sind, die sämtliche Sicherheitsstandards erfüllen.

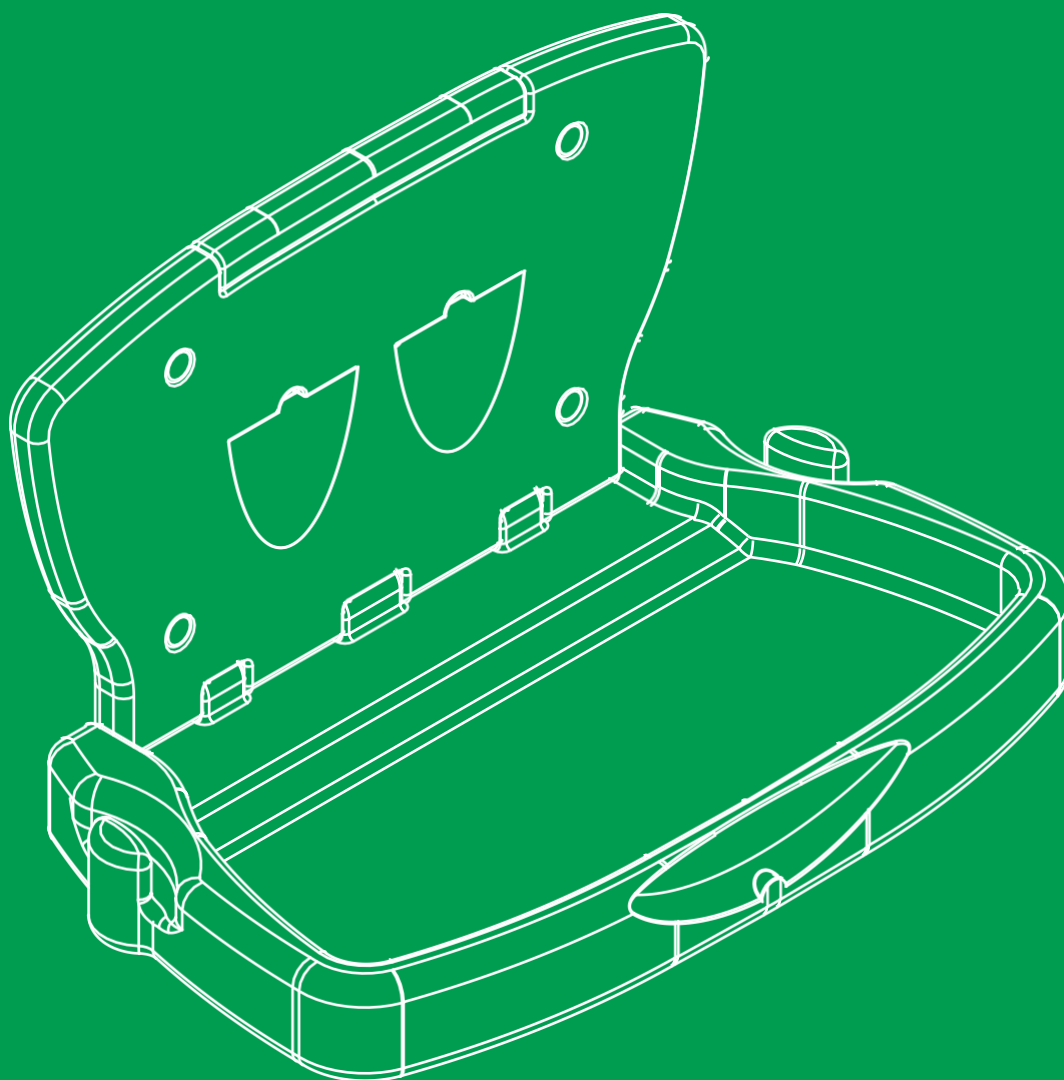

Przewijak – dodatkowe funkcje / Baby changing stations – additional features /  
Babywickeltische – Zusatzfunktionen

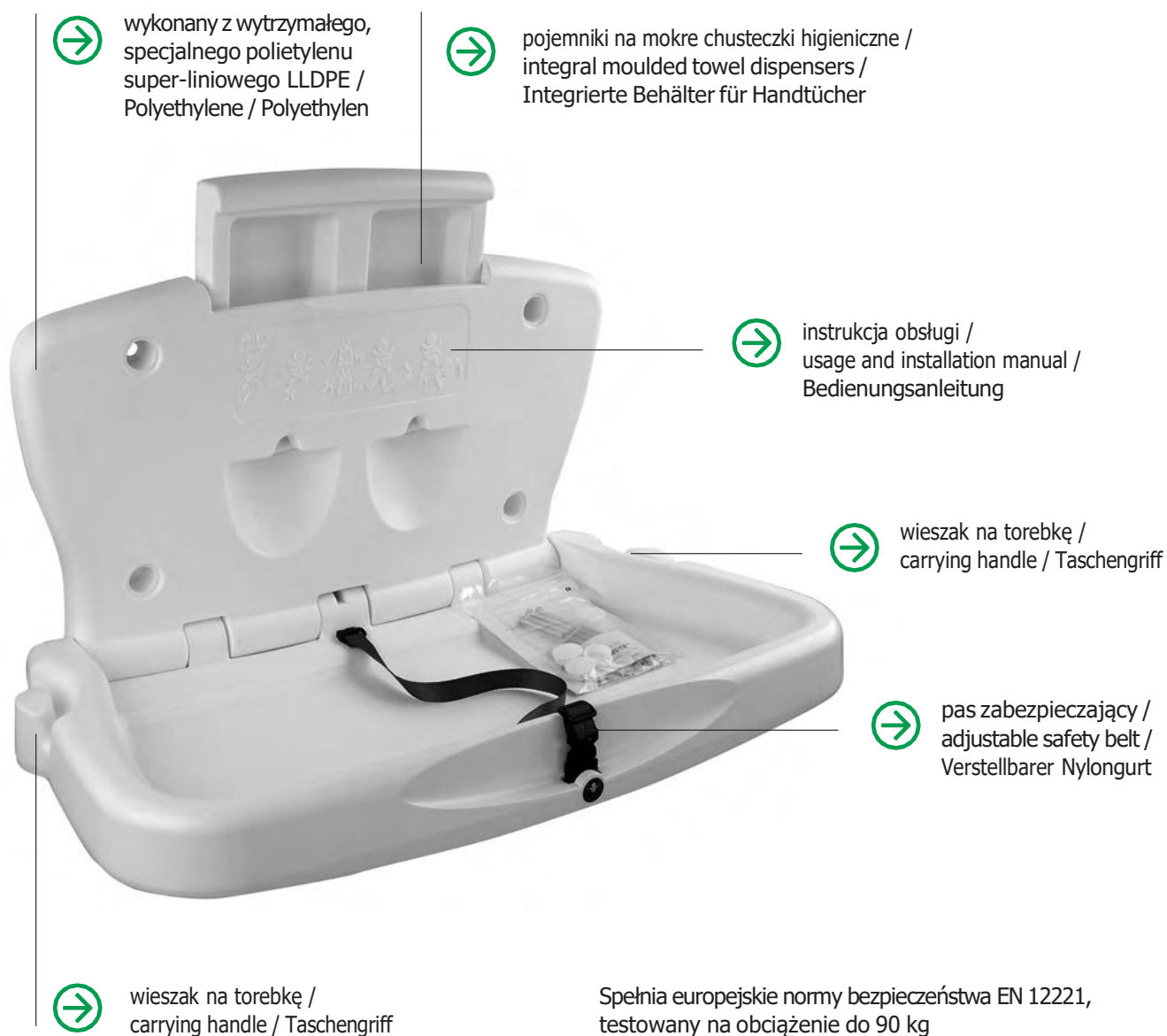

Spełnia europejskie normy bezpieczeństwa EN 12221,  
testowany na obciążenie do 90 kg

**LBCTH**

**Stanowisko do przewijania dzieci i niemowląt składane poziome**  
**Folding baby changing station horizontal**  
**Station zum Wickeln von Kindern und Säuglingen einklappbar horizontal**

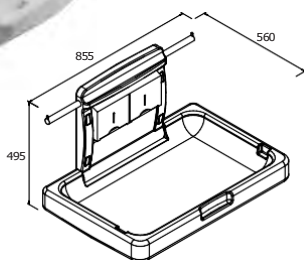

Materiał / material / werkstoff	polietylen / polyethylene / polyethylen
Kolor / colour / farbe	szary / grey / grau
Wymiary przewijaka (otwarte) / dimensions (open) / maße (geöffnet)	495 x 855 x 560 mm
Wymiary przewijaka (zamknięte) / dimensions (closed) / maße (geschlossen)	107 x 855 x 560 mm
Maksymalne obciążenie / maximum strength / maximale belastung	15 kg
Zabezpieczenia / safety / schutzvorrichtungen	regulowany pas nylonowy / adjustable safety belt / Verstellbarer Nylongurt
Mocowanie / mounting / befestigung	ścienne, 4-śrubowe / to the wall, 4 screws / An der Wand mittels 4 Schrauben

## VBCTH

### Stanowisko do przewijania dzieci i niemowląt składane poziome Folding baby changing station horizontal Station zum Wickeln von Kindern und Säuglingen einklappbar horizontal

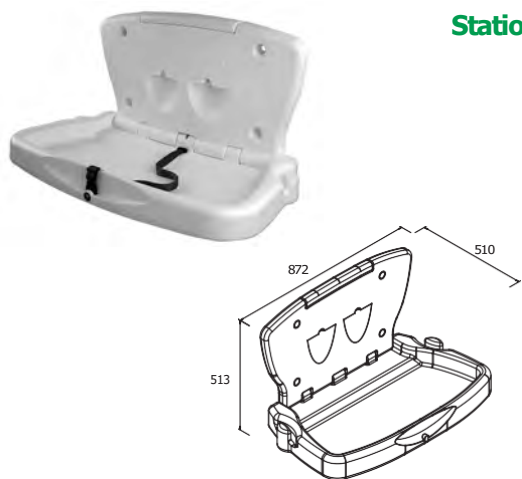

Materiał / material / werkstoff	polietylen / polyethylene / polyethylen
Kolor / colour / farbe	biały / white / weiß
Wymiary przewijaka (otwarte) / dimensions (open) / maße (geöffnet)	513 x 872 x 510 mm
Wymiary przewijaka (zamknięte) / dimensions (closed) / maße (geschlossen)	102 x 872 x 510 mm
Maksymalne obciążenie / maximum strength / maximale belastung	90 kg
Zabezpieczenia / safety / schutzvorrichtungen	regulowany pas nylonowy / adjustable safety belt / Verstellbarer Nylongurt
Mocowanie / mounting / befestigung	ścienne, 4-śrubowe / to the wall, 4 screws / An der Wand mittels 4 Schrauben

> 90  

## VBCTV

### Stanowisko do przewijania dzieci i niemowląt składane pionowe Folding baby changing station vertical Station zum Wickeln von Kindern und Säuglingen einklappbar vertikal

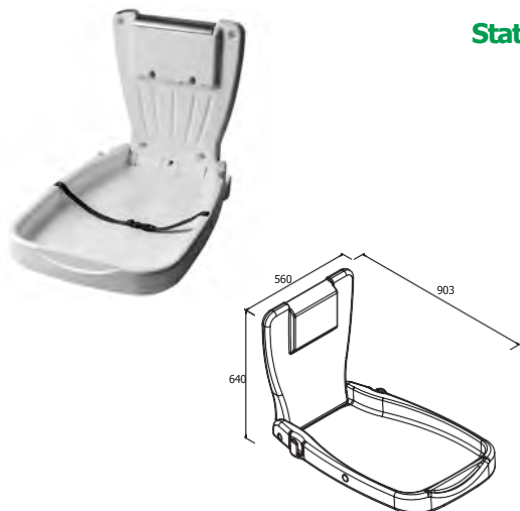

Materiał / material / werkstoff	polietylen / polyethylene / polyethylen
Kolor / colour / farbe	biały / white / weiß
Wymiary przewijaka (otwarte) / dimensions (open) / maße (geöffnet)	640 x 560 x 903mm
Wymiary przewijaka (zamknięte) / dimensions (closed) / maße (geschlossen)	899 x 560 x 117mm
Maksymalne obciążenie / maximum strength / maximale belastung	90 kg
Zabezpieczenia / safety / schutzvorrichtungen	regulowany pas nylonowy / adjustable safety belt / Verstellbarer Nylongurt
Mocowanie / mounting / befestigung	ścienne, 4-śrubowe / to the wall, 4 screws / An der Wand mittels 4 Schrauben

> 90  

## SBCTXIH

### Stanowisko do przewijania dzieci i niemowląt składane poziome SN M Folding baby changing station horizontal SN M Station zum Wickeln von Kindern und Säuglingen einklappbar horizontal SN M

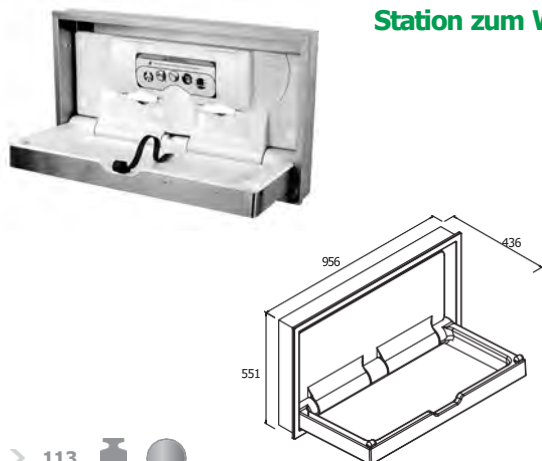

Materiał / material / werkstoff	stal nierdzewna 304 / stainless steel 304 / Edelstahl 304
Kolor / colour / farbe	mat / satin / Matt
Wymiary przewijaka (otwarte) / dimensions (open) / maße (geöffnet)	436 x 956 x 551 mm
Wymiary przewijaka (zamknięte) / dimensions (closed) / maße (geschlossen)	103 x 956 x 551 mm
Maksymalne obciążenie / maximum strength / maximale belastung	113 kg
Zabezpieczenia / safety / schutzvorrichtungen	regulowany pas nylonowy / adjustable safety belt / Verstellbarer Nylongurt
Mocowanie / mounting / befestigung	ścienne, wnękowe / built-in / Wand-, Unterputzmontage

> 113  

# Kosze na śmieci / Wastepaper bins / Abfallbehälter

---

Szeroka oferta koszy na odpady obejmuje kosze łazienkowe plastikowe i metalowe, w tym pojemniki na odpady medyczne i kosze sanitarne do toalet damskich.

A broad range of waste baskets includes plastic and metal bathroom baskets, including containers for medical waste and sanitary baskets for ladies rooms.

Eine breite Palette von Abfallkörben umfasst Kunststoff- und Metallbadezimmereimer, darunter medizinische Abfallbehälter und Sanitärkörbe für Frauentoiletten.

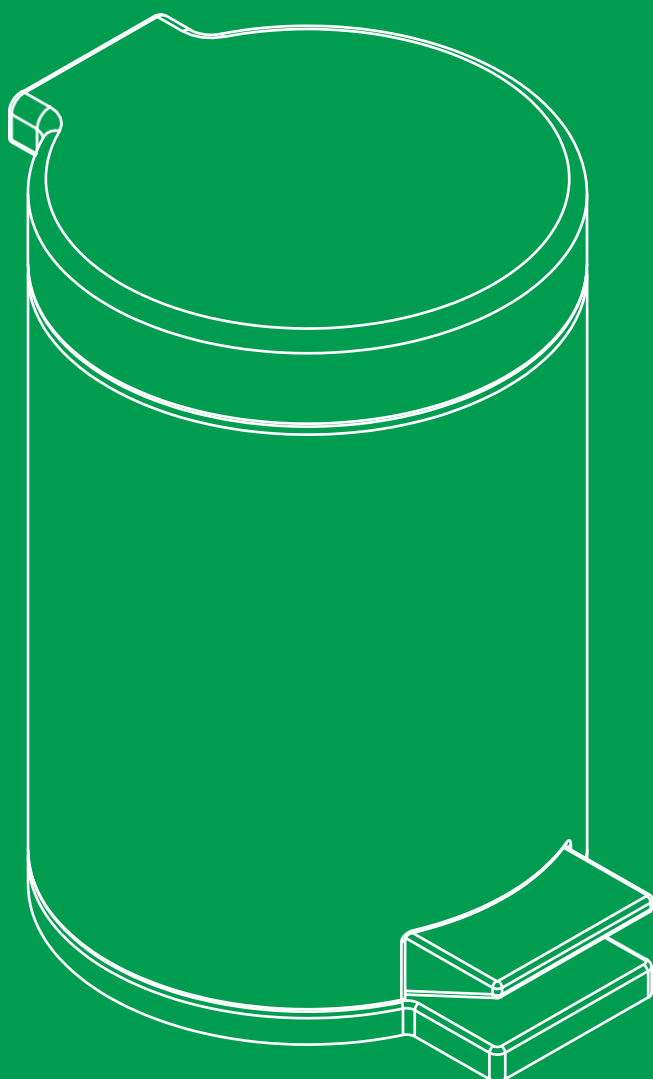



## WBE5MP / 12JP / 20JP / 30MP

## Kosze na śmieci ECO / Wastepaper bins ECO / Abfallbehälter ECO

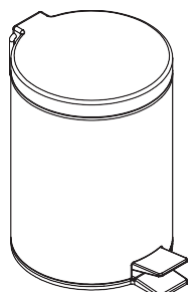

Materiał / material / werkstoff	stal nierdzewna 304 / stainless steel 304 / Edelstahl 304
Kolor / colour / farbe	połysk / brilliance / Glänzend
Otwieranie pokrywy / open / öffnen bzw. Schließen des Deckels	na pedał / pedal / Fußpedal
Wyposażenie / Equipment / Ausstattung	wewnętrzny pojemnik z plastiku ABS, specjalny uchwyt ułatwiający przenoszenie / plastic inner container, special handle for easy carrying / Innenbehälter aus ABS-Kunststoff, Spezieller Griff für einfachen Transport

### WBE5MP

Pojemność / capacity / fassungsvermögen	5 l
Wymiary / dimensions / maße	255 x Ø 185 mm

### WBE12JP

Pojemność / capacity / fassungsvermögen	12l
Wymiary / dimensions / maße	360 x Ø 220 mm

### WBE20JP

Pojemność / capacity / fassungsvermögen	20l
Wymiary / dimensions / maße	440 x Ø 275 mm

### WBE30MP

Pojemność / capacity / fassungsvermögen	30l
Wymiary / dimensions / maße	444 x Ø 315 mm

## WBP3JS / 5JS / 12JS / 20JS

## Kosze na śmieci / Wastepaper bins / Abfallbehälter

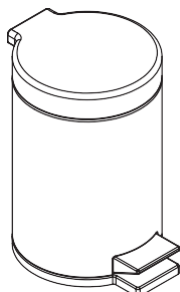

Materiał / material / werkstoff	stal nierdzewna 304 / stainless steel 304 / Edelstahl 304
Kolor / colour / farbe	mat / satin / Matt
Otwieranie pokrywy / open / öffnen bzw. Schließen des Deckels	na pedał / pedal / Fußpedal
Wyposażenie / equipment / ausstattung	wewnętrzny pojemnik z plastiku ABS, specjalny uchwyt ułatwiający przenoszenie / plastic inner container, special handle for easy carrying / Innenbehälter aus ABS-Kunststoff, Spezieller Griff für einfachen Transport

### WBE3JS

Pojemność / capacity / fassungsvermögen	3l
Wymiary / dimensions / maße	240 x Ø180 mm

### WBP5JS

Pojemność / capacity / fassungsvermögen	5l
Wymiary / dimensions / maße	290 x Ø 180 mm

### WBP12JS

Pojemność / capacity / fassungsvermögen	12l
Wymiary / dimensions / maße	360 x Ø 220 mm

### WBP20JS

Pojemność / capacity / fassungsvermögen	20l
Wymiary / dimensions / maße	440 x Ø 275 mm

## WB7SJB

## Kosz naścienny na odpadki higieniczne 7l SN M Hygienic waste bin 7l SN M Wandbehälter für Hygieneabfälle 7l SN M

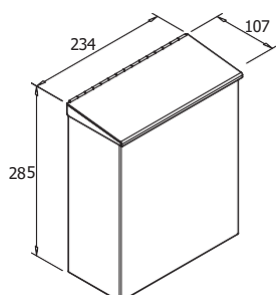

Materiał / material / werkstoff	stal nierdzewna 430 / 430 stainless steel / Edelstahl 430
Kolor / colour / farbe	mat / satin / Matt
Pojemność / capacity / fassungsvermögen	7l
Wymiary / dimensions / maße	285 x 234 x 107 mm

## WB16SMB / 28SMB

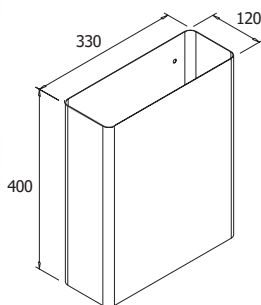

## Kosz naścienny 16l / 28l SN M Wall-mounted wastepaper bin 16l / 28l SN M Wandbehälter 16l / 28l SN M

Materiał / material / werkstoff	stal nierdzewna 430 / 430 stainless steel / Edelstahl 430
Kolor / colour / farbe	mat / satin / Matt

### WB16SMB

Pojemność / capacity / fassungsvermögen	16l
Wymiary / dimensions / maße	400x330x120 mm

### WB28SMB

Pojemność / capacity / fassungsvermögen	28l
Wymiary / dimensions / maße	510x350x155 mm

## WB30S / 50S

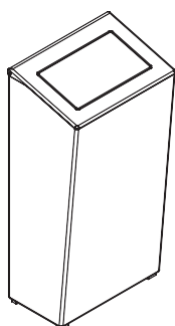

## Kosz na śmieci z pokrywą wiszący 30l / 50l SN M Wall-mounted wastebin with cover 30l / 50l SN M Abfallbehälter mit Deckel hängend 30l / 50l SN M

Materiał / material / werkstoff	stal nierdzewna 430 / 430 stainless steel / Edelstahl 430
Kolor / colour / farbe	mat / satin / Matt

### WB30S

Pojemność / capacity / Fassungsvermögen	30l
Wymiary / dimensions / maße	625x307x214 mm

### WB50S

Pojemność / capacity / Fassungsvermögen	50l
Wymiary / dimensions / maße	700x400x220 mm

## WB40POW

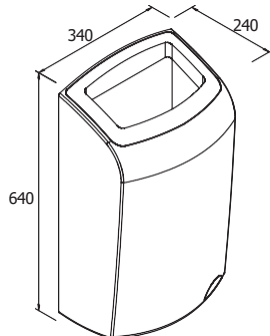

## Kosz naścienny na ręczniki papierowe 40l Hygienic wastepaper bin 40l Wandbehälter für Papiertücher 40l

Materiał / material / werkstoff	plastik ABS / plastic ABS / ABS-Kunststoff
Kolor / colour / farbe	biało - szary / white - grey / Weiß - grau
Pojemność / capacity / fassungsvermögen	40l
Wymiary / dimensions / maße	640 x 340 x 240 mm

## WBS3.30

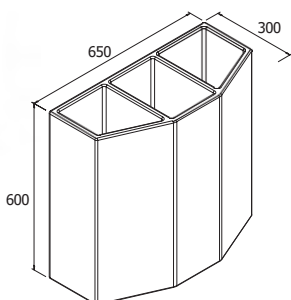

## Kosz do segregacji odpadów 30l / Segregated waste bin 30l / Abfalltrennbehälter 30l

Materiał / material / werkstoff	stal nierdzewna / stainless steel / Edelstahl
Kolor / colour / farbe	mat / satin / Matt
Pojemność / capacity / fassungsvermögen	3 x 30l
Wymiary / dimensions / maße	600 x 650 x 200 - 300 mm
Wyposażenie / equipment / ausstattung	komory oddzielone ściankami stalowymi, wyposażone w uchwyty na worki, oznaczenia segregacyjne: szkło, papier, plastik / separated by steel walls, equipped with frame bags, symbols for glass, paper, plastic / Getrennt mit Wänden aus Stahl, ausgestattet mit Beutelhalterungen, Abfalltrennzeichnungen: Glas, Papier, Kunststoff

## WBS3.80

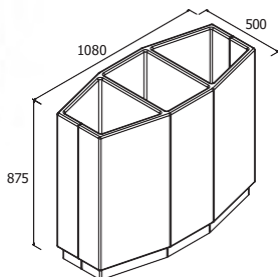

## Kosz do segregacji odpadów 80l / Segregated waste bin 80l / Abfalltrennbehälter 80l

Materiał / material / werkstoff	stal nierdzewna / stainless steel / Edelstahl
Kolor / colour / farbe	mat / satin / Matt
Pojemność / capacity / fassungsvermögen	3 x 80l
Wymiary / dimensions / maße	875 x 1080 x 500 mm
Wyposażenie / equipment / ausstattung	komory oddzielone ściankami stalowymi, wyposażone w uchwyty na worki, oznaczenia segregacyjne: szkło, papier, plastik / separated by steel walls, equipped with frame bags, symbols for glass, paper, plastic / Getrennt mit Wänden aus Stahl, ausgestattet mit Beutelhalterungen, Abfalltrennbezeichnungen: Glas, Papier, Kunststoff

## WBCT150SNM

## Kołnierz nablátowy do kosza na odpady / Counter top flange for waste bin / Aufsatzflansch für Abfallbehälter



Materiał / material / werkstoff	stal nierdzewna 304 / stainless steel 304 / 304 Edelstahl
Kolor / colour / farbe	mat / satin / Matt
Wymiary / dimensions / maße	120 mm, średnica zewnętrzna 160 mm, średnica wewnętrzna 150mm / 120 mm, outer diameter Ø 160 mm, inner diameter Ø 150 mm / 120 mm, Außendurchmesser 160 mm, Innendurchmesser 150 mm

# Aksesoria / Accessories / Zubehör

---

Szczotki toaletowe i wieszaki to niezbędne akcesoria łazienkowe w każdej toalecie. Dostępne w wykończeniu matowym i polerowanym o różnorodnym wzornictwie.

Toilet brushes and hangers are necessary accessories in each and every toilet. They are available with a matt or polished finish and a variety of designs.

Toilettenbürsten und Haken sind ein unverzichtbares Badzubehör in jeder Toilette. Sie sind matt und poliert mit diversen Designmustern erhältlich.

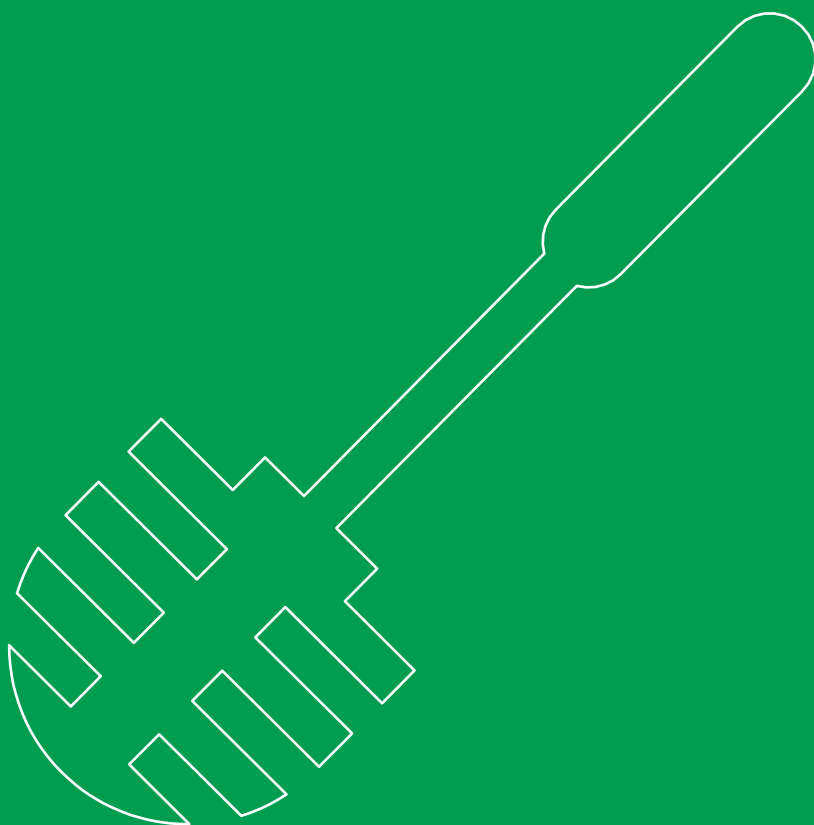

## TB02FMB

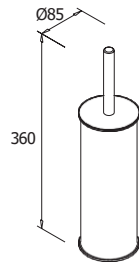

### Szczotka do WC wolnostojąca SN M Freestanding toilet brush SN M Freistehenden Toilettenbürste SN M

Materiał / material / werkstoff	stal nierdzewna 430 / stainless steel 430 / 430 Edelstahl
Kolor / colour / farbe	mat / satin / Matt
Wymiary / dimensions / maße des Seifenspenders	360 x 85 x 85 mm



## ECP212211

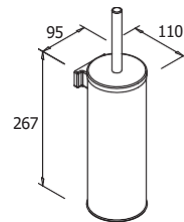

### Szczotka do WC ścienna SN M / Wall-mounted toilet brush SN M / An der Wand Toilettenbürste SN M

Materiał / material / werkstoff	stal nierdzewna 304 / stainless steel 304 / 304 Edelstahl
Kolor / colour / farbe	mat / satin / Matt
Wymiary / dimensions / maße des Seifenspenders	265 x 100 x 100 mm



## TB01WMP

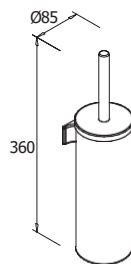

### Szczotka do WC ścienna SN P / Wall-mounted toilet brush SN P / An der Wand Toilettenbürste SN P

Materiał / material / werkstoff	stal nierdzewna 430 / stainless steel 430 / 430 Edelstahl
Kolor / colour / farbe	mat / satin / Matt
Wymiary / dimensions / maße des Seifenspenders	360 x 85 x 85 mm



## A1005



### Szczotka do WC SN M / Toilet brush SN M / Toilettenbürste SN M

Materiał / material / werkstoff	stal nierdzewna 304 / stainless steel 304 / 304 Edelstahl
Kolor / colour / farbe	mat / satin / Matt
Wymiary / dimensions / maße des Seifenspenders	420 x 110 x 100 mm



## ECRU692410



### Szczotka do WC / Toilet brush / Toilettenbürste

Materiał / material / werkstoff	stop cynku i aluminium (zmal), szkło dymione / zinc & aluminium-alloy (zmal), smoked glass / Zink- und Aluminiumlegierung, Rauchglas
Kolor / colour / farbe	chrom błyszczący / chrome / chrom glänzend
Wymiary / dimensions / maße des Seifenspenders	385 x 115 x 165 mm



## ECO7031082

### Wieszak łazienkowy pojedynczy / Single hanger / Badhaken einzeln



Materiał / material / werkstoff	mosiądz / brass / Messing
Kolor / colour / farbe	mat / satin / Matt
Wymiary / dimensions / maße des Seifenspenders	32 x 17 x 65 mm

## N16506.B / N16506.S

### Wieszak łazienkowy pojedynczy SN P / Single hanger SN P / Badhaken einzeln SN P



Materiał / material / werkstoff	stal nierdzewna 304 / stainless steel 304 / 304 Edelstahl
Kolor / colour / farbe	chrom błyszczący / chrome / chrom glänzend
Wymiary / dimensions / maße des Seifenspenders	48 x 48 x 44 mm

### Wieszak łazienkowy pojedynczy SN M / Single hanger SN M / Badhaken einzeln SN M

Materiał / material / werkstoff	stal nierdzewna 304 / stainless steel 304 / 304 Edelstahl
Kolor / colour / farbe	mat / satin / Matt
Wymiary / dimensions / maße des Seifenspenders	48 x 48 x 44 mm

## N09016.B / N09016.S

### Wieszak łazienkowy pojedynczy SN P / Single hanger SN P / Badhaken einzeln SN P



Materiał / material / werkstoff	stal nierdzewna 304 / stainless steel 304 / 304 Edelstahl
Kolor / colour / farbe	chrom błyszczący / chrome / chrom glänzend
Wymiary / dimensions / maße des Seifenspenders	50 x 50 x 45 mm

### Wieszak łazienkowy pojedynczy SN M / Single hanger SN M / Badhaken einzeln SN M

Materiał / material / werkstoff	stal nierdzewna 304 / stainless steel 304 / 304 Edelstahl
Kolor / colour / farbe	mat / satin / Matt
Wymiary / dimensions / maße des Seifenspenders	50 x 50 x 45 mm

## N09017.B / N09017.S

### Wieszak łazienkowy podwójny SN P / Double hanger SN P / Badhaken doppelt SN P



Materiał / material / werkstoff	stal nierdzewna 304 / stainless steel 304 / 304 Edelstahl
Kolor / colour / farbe	chrom błyszczący / chrome / chrom glänzend
Wymiary / dimensions / maße des Seifenspenders	50 x 100 x 45 mm

### Wieszak łazienkowy podwójny SN M / Double hanger SN M / Badhaken doppelt SN M

Materiał / material / werkstoff	stal nierdzewna 304 / stainless steel 304 / 304 Edelstahl
Kolor / colour / farbe	mat / satin / Matt
Wymiary / dimensions / maße des Seifenspenders	50 x 100 x 45 mm

# Dla niepełnosprawnych / for disabled people / für Behinderte

---

Uchwyty proste i kątowe, poręczne stałe i uchylne, mocowane do ściany i podłoga, lustra uchylne oraz siedziska prysznicowe dostępne w różnym wykończeniu odgrywają decydującą rolę w zapewnieniu bezpieczeństwa i wygody.

Straight and angled bar, fixed and folding bar, wall- and floor-mounted, hinged mirrors and shower seats available in various options of finish play an essential role in providing security and comfort.

Gerade und eckige Griffe, feste und kippbare Handläufe mit Wand- und Bodenbefestigung sowie Kippspiegel und Duschsitze in verschiedenen Ausführungen sind für die Gewährleistung der Sicherheit und des Komforts entscheidend.



## S32UP3 / 4 / 5 / 6 / 7 / 8 / 9

### Poręcz prosta dla niepełnosprawnych / Straight bar for disabled people / Haltegriff für Behinderte gerade



Materiał / material / werkstoff	stal węglowa; stal nierdzewna / carbon steel; stainless steel / Kohlenstoffstahl; Edelstahl
Kolor / colour / farbe	Ffarba epoksydowa biała; mat; poler / white epoxy; satin; brilliance / Epoxidfarbe weiß; Matt; Glänzend
Długość / length / haltegrifflänge	3 – 30 cm, 4 - 40 cm, 5 – 50 cm, 6 – 60 cm, 7 – 70 cm, 8 – 80 cm, 9 – 90 cm
Wymiary / dimensions / maße	3 – 75 x 375 x 102 mm, 4 – 75 x 475 x 102 mm, 5 – 75 x 575 x 102 mm, 6 – 75 x 675 x 102 mm, 7 – 75 x 775 x 102 mm, 8 – 75 x 875 x 102 mm, 9 – 75 x 975 x 102 mm
Średnica rury / pipe diameter / durchmesser des Rohres	Ø 32
Mocowanie / mounting / befestigung	naścienna / to wall / An der Wand

## S32UUL5,5 / P5,5

### Poręcz stała dla niepełnosprawnych 3-podporowa lewa Fixed bar three support points (left) Fester Haltegriff für Behinderte mit 3 Verstrebungen links



Materiał / material / werkstoff	stal węglowa; stal nierdzewna / carbon steel; stainless steel / Kohlenstoffstahl; Edelstahl
Kolor / colour / farbe	farba epoksydowa biała; mat; poler / white epoxy; satin; brilliance / Epoxidfarbe weiß; Matt; Glänzend
Długość / length / haltegrifflänge	55 cm
Wymiary / dimensions / maße	150 x 550 x 150 mm
Średnica rury / pipe diameter / durchmesser des Rohres	Ø 32
Mocowanie / mounting / befestigung	naścienna / to wall / An der Wand

## S32UUS6 / 7 / 8

### Poręcz stała łukowa / Fixed arched bar / Fester Haltegriff für Behinderte bogenförmig

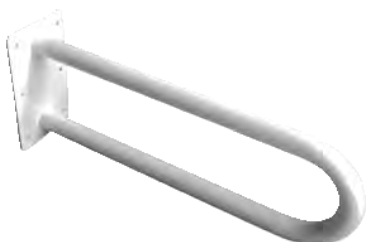

Materiał / material / werkstoff	stal węglowa; stal nierdzewna / carbon steel; stainless steel / Kohlenstoffstahl; Edelstahl
Kolor / colour / farbe	farba epoksydowa biała; mat; poler / white epoxy; satin; brilliance / Epoxidfarbe weiß; Matt; Glänzend
Długość / length / haltegrifflänge	6 – 60 cm, 7 – 70 cm, 8 – 80 cm
Wymiary / dimensions / maße	6 – 300 x 100 x 600 mm, 7 – 300 x 100 x 700 mm, 8 – 300 x 100 x 800 mm
Średnica rury / pipe diameter / durchmesser des Rohres	Ø 32
Mocowanie / mounting / befestigung	naścienna / to wall / An der Wand

## S32UUWC6 / 8

### Poręcz uchylna dla niepełnosprawnych / Folding bar for disabled people / Haltegriff für Behinderte schwenkbar



Materiał / material / werkstoff	stal węglowa; stal nierdzewna / carbon steel; stainless steel / Kohlenstoffstahl; Edelstahl
Kolor / colour / farbe	farba epoksydowa biała; mat; poler / white epoxy; satin; brilliance / Epoxidfarbe weiß; Matt; Glänzend
Długość / length / haltegrifflänge	6 – 60 cm, 8 – 80 cm
Wymiary / dimensions / maße	6 – 220 x 600 x 120 mm, 8 – 220 x 800 x 120 mm
Średnica rury / pipe diameter / durchmesser des Rohres	Ø 32
Mocowanie / mounting / befestigung	naścienna / to wall / An der Wand



## S32UKS

### Poręcz kątowa dla niepełnosprawnych 130° / Angled bar for disabled people 130° / Haltegriff für Behinderte gebeugt 130°



Materiał / material / werkstoff	stal węglowa; stal nierdzewna / carbon steel; stainless steel / Kohlenstoffstahl; Edelstahl
Kolor / colour / farbe	farba epoksydowa biała; mat; poler / white epoxy; satin; brilliance / Epoxidfarbe weiß; Matt; Glänzend
Wymiary / dimensions / maße	300 x 300x 102 mm
Średnica rury / pipe diameter / durchmesser des Rohres	Ø 32
Mocowanie / mounting / befestigung	naścienna / to wall / An der Wand

## S32UUWCW6 / 7

### Poręcz uchylna stojąca dla niepełnosprawnych Folding bar with column for disabled people Haltegriff für Behinderte schwenkbar stehend



Materiał / material / werkstoff	stal węglowa; stal nierdzewna / carbon steel; stainless steel / Kohlenstoffstahl; Edelstahl
Kolor / colour / farbe	farba epoksydowa biała; mat; poler / white epoxy; satin; brilliance / Epoxidfarbe weiß; Matt; Glänzend
Długość / length / Haltegrifflänge	6 – 60 cm, 7 – 70 cm
Wymiary / dimensions / maße	6 – 700 x 102x 600 mm, 7 – 700 x 102 x 700 mm
Średnica rury / pipe diameter / durchmesser des Rohres	Ø 32
Mocowanie / mounting / befestigung	podłogowe / to floor / Boden

## S32UKL6/4 / L8/4 / P6/4 / P8/4

### Poręcz kątowa dla niepełnosprawnych 90° Angled bar for disabled people 90° Haltegriff für Behinderte gebeugt 90°



Materiał / material / werkstoff	stal węglowa; stal nierdzewna / carbon steel; stainless steel / Kohlenstoffstahl; Edelstahl
Kolor / colour / farbe	farba epoksydowa biała; mat; poler / white epoxy; satin; brilliance / Epoxidfarbe weiß; Matt; Glänzend
Wymiary / dimensions / maße	6/4 – 600 x 400 x 102 mm, 8/4 – 800 x 400 x 102 mm
Średnica rury / pipe diameter / durchmesser des Rohres	Ø 32
Mocowanie / mounting / befestigung	naścienna / to wall / An der Wand

## S32UK6

### Poręcz kątowa dla niepełnosprawnych 90° Angled bar for disabled people 90° Haltegriff für Behinderte gebeugt 90°



Materiał / material / werkstoff	stal węglowa; stal nierdzewna / carbon steel; stainless steel / Kohlenstoffstahl; Edelstahl
Kolor / colour / farbe	farba epoksydowa biała; mat; poler / white epoxy; satin; brilliance / Epoxidfarbe weiß; Matt; Glänzend
Wymiary / dimensions / maße	600 x 600x 102 mm
Średnica rury / pipe diameter / durchmesser des Rohres	Ø 32
Mocowanie / mounting / befestigung	naścienna / to wall / An der Wand

## S32ZP SWB / SNM / SN P



### Uchwyt na papier toaletowy do poręczy dla niepełnosprawnych Paper toilet holder for grab bar Toilettenpapierhalter für Handläufe für Personen mit Behinderungen

Materiał / material / werkstoff	stal węglowa; stal nierdzewna / carbon steel; stainless steel / Kohlenstoffstahl; Edelstahl
Kolor / colour / farbe	farba epoksydowa biała; mat; poler / white epoxy; satin; brilliance / Epoxidfarbe weiß; Matt; Glänzend
Wymiary / dimensions / maße	127 x 147 mm
Średnica rury / pipe diameter / durchmesser des Rohres	Ø 32

## SKPU2 / SKPU



### Siedzisko prysznicowe uchylne / Folding shower seat / Duschsitz schwenkbar

Materiał / material / werkstoff	stal węglowa; stal nierdzewna / carbon steel; stainless steel / Kohlenstoffstahl; Edelstahl
Kolor / colour / farbe	farba epoksydowa biała; mat; poler / white epoxy; satin; brilliance / Epoxidfarbe weiß; Matt; Glänzend
Wymiary / dimensions / maße	SKPU2 - 150 x 440 x 460 mm, SKPU - 200 x 440 x 460mm
Średnica rury / pipe diameter / durchmesser des Rohres	Ø 32
Wyposażenie / equipment / ausstattung	SKPU - ze wspornikami / with supports / mit Stützen

## N08026 / 23.S / 24.S



### Lustro uchylne dla niepełnosprawnych Retractable mirror for disabled people Spiegel schwenkbar für Behinderte

Materiał / material / werkstoff	26- plastik ABS (rama); 23.S; 24.S - stal nierdzewna / stainless steel / Edelstahl
Kolor / colour / farbe	26 - biały / white / weiß; 23.S/24.S - mat / satin / Matt
Wymiary / dimensions / maße	26 - 390 x 540 mm; 23.S - 700 x 500 mm; 24.S - 800 x 600 mm
Średnica rury / pipe diameter / durchmesser des Rohres	Ø 32